

JACK-IN PILE DESIGN – MALAYSIAN EXPERIENCE AND DESIGN APPROACH TO EC7

Chow Chee-Meng & Tan Yean-Chin

G&P Geotechnics Sdn Bhd

ABSTRACT: Jack-in pile foundation has been successfully adopted in Malaysia since the 1990s and currently, large diameter spun piles up to 600mm in diameter with working load up to 3000kN have been successfully adopted for high-rise buildings of up to 45-storeys. This paper summarises some Malaysian experience in design and construction of high capacity jack-in pile systems based on results of maintained load tests and settlement monitoring carried out on completed structures. Recommendations on empirical correlations between ultimate shaft resistance (f_{su}) and ultimate base resistance (f_{bu}) with SPT 'N' are also presented. Comparison is made with existing correlations which are based on conventional driven pile systems. Based on local experience, some suggested values are also presented for partial and correlation factors for ultimate limit states design and model factors that are used in conjunction with Design Approach 1 of Eurocode 7 (EC7) for jack-in pile design under axial compression loads. The suggested factors that can be the basis for formulation of the Malaysian National Annex to EC7 for jack-in pile design under axial compression load are rationalized to ensure smooth transition from current practice based on working state principles to the limit state design of EC7. Finally results of pile load tests from different sites are also presented for verification of the suggested EC7 Malaysian National Annex values.

1.0 INTRODUCTION

Jack-in pile foundation has been successfully adopted in Malaysia since the 1990s and currently, large diameter spun piles of up to 600mm diameter with working loads of up to 3000kN have been successfully adopted for high-rise buildings of up to 45-storeys. The popularity of jack-in pile foundation systems especially for construction works in urban areas is due to their relatively lower noise and lower vibration compared to conventional piling systems such as driven piles. Jack-in pile foundation also offer advantages in terms of faster construction rates, better quality control, less pile damage and cleaner site conditions as it does not require the use of stabilizing liquid/drilling fluid typically associated with bored piles and micropiles. In practice, piles installed using the jack-in method are expected to be shorter than driven piles. This is because driven piles are often driven to greater length than is truly necessary due to the uncertainties associated with their geotechnical capacity during driving. However, jack-in piles are jacked to the specified capacity and therefore, result in savings without compromising the safety, serviceability requirements and integrity of the pile foundation. However, like all available systems, jack-in piles also have their drawbacks, such as the need for a relatively stronger platform to support large and heavy machinery and a generally larger working area to install the piles. However, the drawbacks can be managed if the designer is aware of these limitations and jack-in pile foundation systems have been

successfully adopted in congested condominium developments, piling works at different platform levels with limited working space and works carried out at lower ground level associated with basement construction.



Figure 1. Typical high capacity jack-in pile machine in Malaysia.

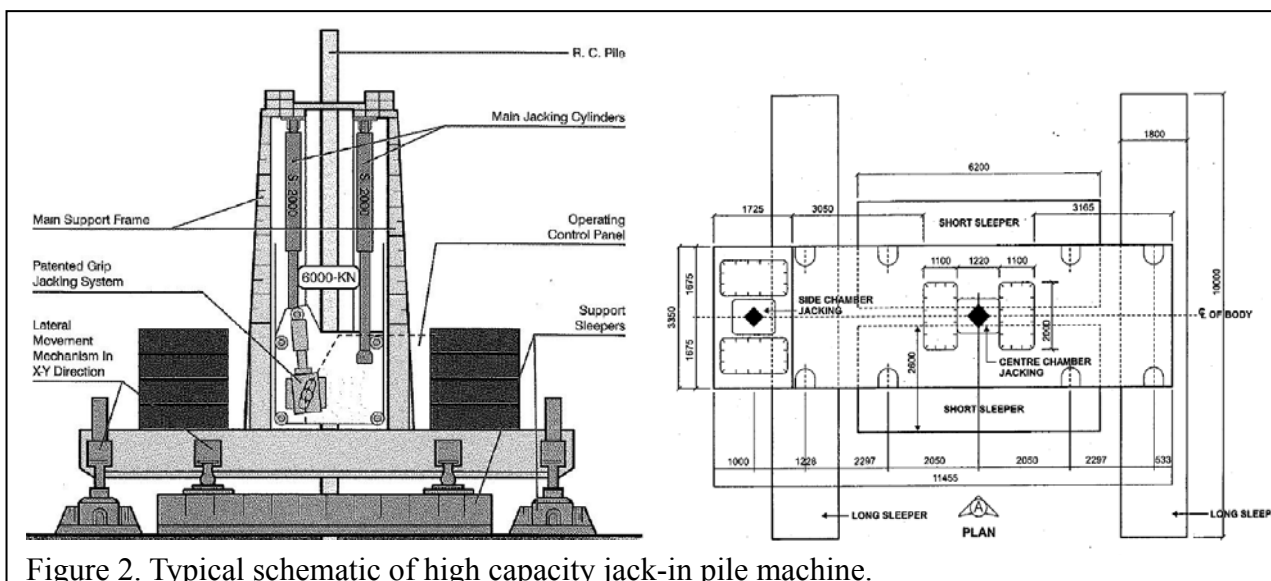

Figure 2. Typical schematic of high capacity jack-in pile machine.

Table 1. Key technical data of high capacity jack-in pile machines.

ITEM	TECHNICAL DATA
Maximum Jacking Force	6000kN
Applicable Spun Pile Diameter	250mm to 600mm
Applicable RC Square Pile Size	250mm to 400mm
Self Weight (Excluding counterweight)	178t to 200t
Overall dimension (Length x Width x Height)	11.1 x 10.0 x 9.1 13.55 x 12.0 x 7.44
Minimum clearance required for piling works (Centre jacking)	5.5m to 6.9m
Bearing pressure on sleeper	Up to 175kN/m ²

Figures 1 and 2 show a typical high capacity jack-in pile machine in Malaysia and a schematic of the machine respectively. Table 1 summarises some key technical data for the machines.

In this paper, a review of current design and construction practice adopted in Malaysia for jack-in pile foundation is presented. Comparisons are also made with the EC7 methodology especially concerning the model factors and partial factors to be adopted together with some suggested values for development of EC7 Malaysian National Annex (MY-NA) for pile foundation under axial compression loads. Finally, results of pile load tests are also presented for verification of suggested EC7 Malaysian National Annex values.

2.0 MALAYSIAN CONVENTIONAL DESIGN PRACTICE FOR GEOTECHNICAL CAPACITY OF PILES

2.1 Factor of Safety

In Malaysia, the Factors of Safety (FOS) normally used in static calculation of pile geotechnical capacity are partial FOS on shaft (F_s) and base (F_b) respectively; and the global FOS (F_g) on total capacity. The lower geotechnical capacity obtained from both methods using the following equations is adopted as allowable geotechnical capacity

$$Q_{ag} = \frac{Q_{su}}{F_s} + \frac{Q_{bu}}{F_b} \quad (\text{eq.1})$$

$$Q_{ag} = \frac{Q_{su} + Q_{bu}}{F_g} \quad (\text{eq.2})$$

Note: Use the lower of Q_{ag} obtained from eq. 1 and eq. 2 above.

Where:

Q_{ag} = Allowable geotechnical capacity

Q_{su} = Ultimate shaft capacity = $\sum_i (f_{su} \times A_s)$

i = Number of soil layers

Q_{bu} = Ultimate base capacity = $f_{bu} A_b$

f_s = Unit shaft resistance for each layer of embedded soil

f_b = Unit base resistance for the bearing layer of soil

A_s = Pile shaft area

A_b = Pile base area

F_s = Partial Factor of Safety for Shaft Resistance (generally 1.5)

F_b = Partial Factor of Safety for Base Resistance (generally 3.0)

F_g = Global Factor of Safety for Total Resistance (Base + Shaft) generally 2.0

2.2 Design of Geotechnical Capacity in Soil (Driven Piles)

As the jack-in pile foundation system is relatively new, available data and experience on jack-in piles are still limited. As such, geotechnical design of jack-in pile is normally based on driven pile experience, which is expected to be conservative. Recent experiences by the Authors, as well as other research findings, have shown that geotechnical capacity of jack-in piles is expected to be higher compared to driven piles and this will be further elaborated in the following sections.

In Malaysia, the design geotechnical capacity in soil for driven piles is usually based on semi-empirical methods where correlations have been extensively developed relating both shaft resistance and base resistance of piles to N-values from Standard Penetration Tests (SPT). In the correlations established, SPT-N values generally refer to uncorrected values before pile installation.

The commonly used correlations for piles are as follows:

$$f_{su} = K_{su} \times \text{SPT-N} \quad (\text{in kPa})$$

$$f_{bu} = K_{bu} \times \text{SPT-N} \quad (\text{in kPa})$$

Where:

K_{su} = Ultimate shaft resistance factor

K_{bu} = Ultimate base resistance factor

SPT'N' = Standard Penetration Tests blow counts (blows/300mm)

Poulos (1989) summarises some correlations between shaft resistance, f_{su} and SPT-N as shown in Table 2.

Table 2. Correlations between shaft resistance, f_{su} and SPT-N, with $f_{su} = \alpha + \beta N$ kN/m² (Poulos, 1989)

SOIL TYPE	α	β	REMARKS	REFERENCES
Cohesionless	0	2.0	f_{su} = average value over shaft N = average SPT along shaft Halve f_{su} for small displacement pile	Meyerhof (1956) Shioi & Fukui (1982)
Cohesionless & cohesive	10	3.3	Pile type not specified $50 \geq N \geq 3$ $f_{su} \neq 170 \text{ kN/m}^2$	Decourt (1982)
Cohesive	0	10	-	Shioi & Fukui (1982)

From Table 2, it can be seen that the ultimate shaft resistance factor, K_{su} generally ranges from 2.0 to 3.0 depending on the size of piles, pile materials, soil strength/stiffness (e.g. SPT-N

values) and soil type. Commonly, K_{su} of 2.5 is used for preliminary design of driven piles prior to load tests. Ultimate base resistance factors, K_{bu} for driven piles are tabulated in Table 3.

Table 3. Correlation between ultimate base resistance factor with soil type.

SOIL TYPE	K_{bu}	REFERENCES
Gravels	500 to 600	Authors local experiences
Sand	400 ⁽¹⁾ to 450 ⁽²⁾	⁽¹⁾ Decourt (1982) ⁽²⁾ Martin et al.(1987)
Silt, Sandy Silt	250 ⁽¹⁾ to 350 ⁽²⁾	⁽¹⁾ Decourt (1982) for residual sandy silts ⁽²⁾ Martin et al.(1987) for silt & sandy silt
Clayey Silt	200	Decourt (1982) for residual clayey silt
Clay	120 ⁽¹⁾ to 200 ⁽²⁾	⁽¹⁾ Decourt (1982) ⁽²⁾ Martin et al.(1987)
Note : $f_{bu} = K_{bu} \times \text{SPT}'N'$ (in kPa)		

Other methods based on simplified soil mechanics concept are also sometimes practised and this is discussed in Tan et al. (2009).

3.0 REVIEW OF GEOTECHNICAL CAPACITY FOR JACK-IN PILES

3.1 Literature Review

Professor Mark Randolph in 2003 presented the 43rd Rankine Lecture titled “Science and empiricism in pile foundation design” (Randolph, 2003) in which he highlighted the importance of residual pressures locked in at the pile base during installation in mobilization of end-bearing resistance. For bored piles, with initially zero base pressure at zero displacement, end-bearing pressure can only be mobilised at relatively large base displacement. However, for driven and jacked piles, significant residual pressures are locked in at the pile base during installation (equilibrated by negative shear stresses along the pile shaft, as if the piles were loaded in tension) (Randolph, 2003). As such, jack-in pile is expected to mobilise higher end-bearing resistance at working load compared to driven piles. This is because the magnitude of residual pressures for jack-in pile is expected to be even greater compared to driven piles.

Beside higher end-bearing resistance at working load, the mobilised shaft friction for jack-in piles is also expected to be higher based on White & Lehane, 2004. White & Lehane, 2004 investigated the phenomenon of decrease in shaft friction in a given soil horizon as the pile tip penetrates to deeper levels or commonly known as friction fatigue. Some of the key findings from their research include:

- a) A greater number of cycles imposed during pile installation leads to a larger reduction

in shaft friction at a given soil horizon. Figure 3, which compares the normalised horizontal stress along the pile shaft with different installation cycles using jack-in and pseudo-dynamic methods clearly shows the reduction in horizontal stress (and hence, shaft friction) along the pile shaft with the increase in installation cycles.

- b) Amplitude of the installation cycles also affects friction fatigue.
- c) Two-way cycling (e.g. vibro-hammer) leads to a greater degradation than one-way cycling.

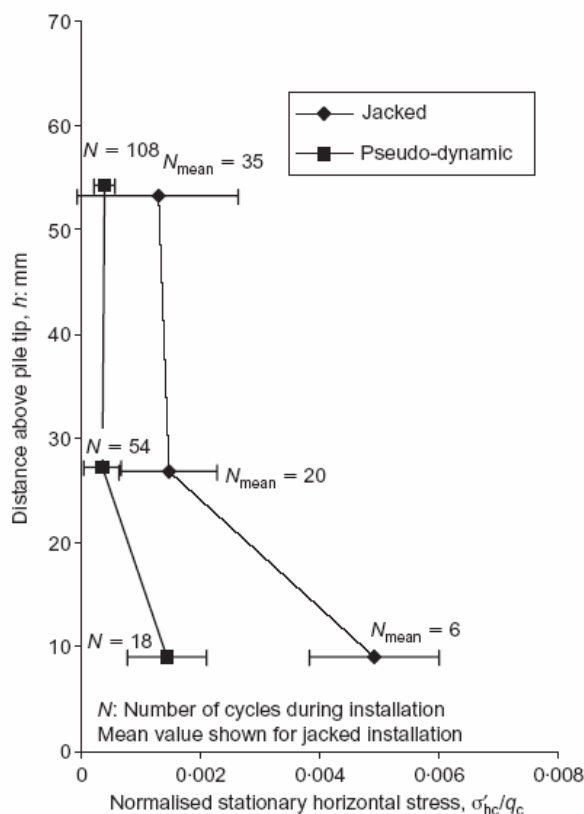

Figure 3. Influence of loading cycles during installation on stationary horizontal stress (White & Lehane, 2004).

In conclusion, White & Lehane (2004) state that “Modern installation techniques of pile jacking involve reduced cycling, and may therefore yield higher shaft friction than conventional dynamic installation methods”.

Deeks, White & Bolton (2005) also presented the response of jack-in displacement piles in sand using the press-in method which is similar to the jack-in method described in this paper. The conclusions from Deeks, White & Bolton (2005) are:

- a) The measured jacking force during installation indicates the plunging capacity of the pile

- b) Jacked piles have a high base stiffness, due to the preloading of the soil below the base during installation, and the presence of residual base load.
- c) The stiffness of jacked piles exceeds typical recommended design stiffnesses for driven and bored piles by factors of more than 2 and 10 respectively.

3.2 Case Histories

Maintained load test results for four (4) different sites in Mont Kiara, Kuala Lumpur and Subang, Selangor are available to assess the performance of the jack-in pile foundation system. The four different sites are as follows:

- a) Site A – 31-storey condominium development
- b) Site B – 45-storey condominium development
- c) Site C – 40 to 43-storey condominium development
- d) Site D – 15-storey condominium development

Figure 4 shows actual view of the condominium tower of Site A which was recently completed and handed over to purchasers and also the condominium tower of Site B where superstructure works have been completed.



Figure 4. Completed condominium towers of Site A and Site B.

In general, all the four sites are underlain by Granite formation with overburden materials mainly consisting of silty SAND/sandy SILT with variable thicknesses. Presence a of gravel layer is also detected in Site D. Typical borehole profiles for the sites are shown in Figures 5, 6, 7 and 8.

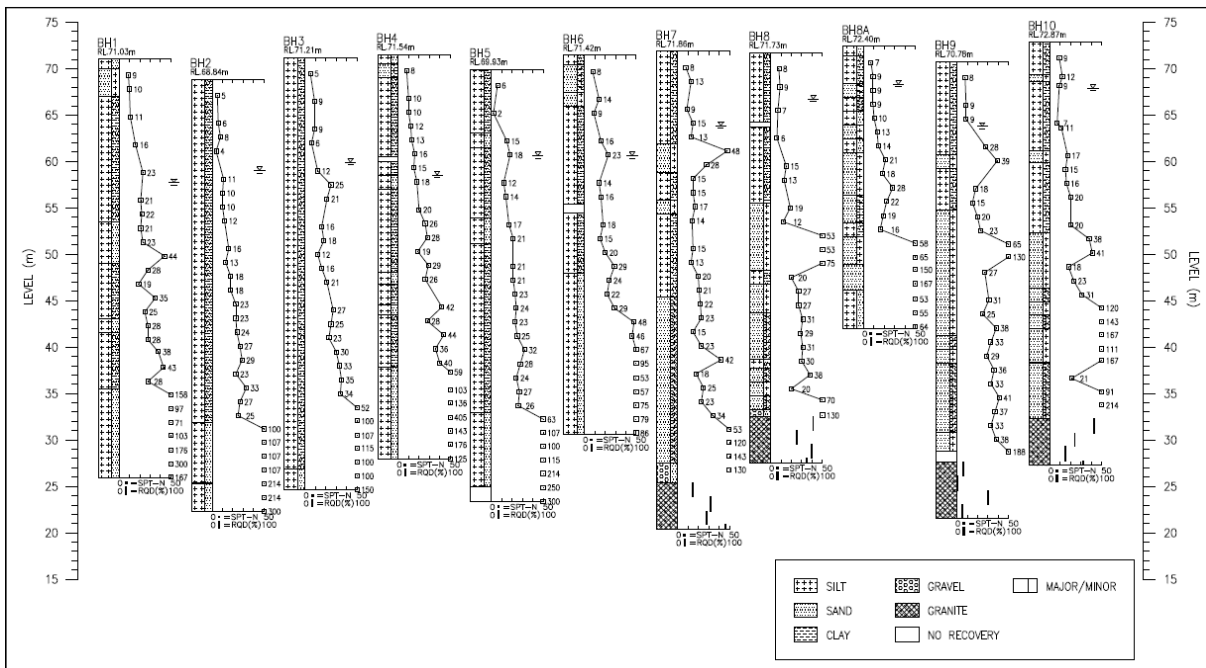

Figure 5. Borehole profiles at Site A.

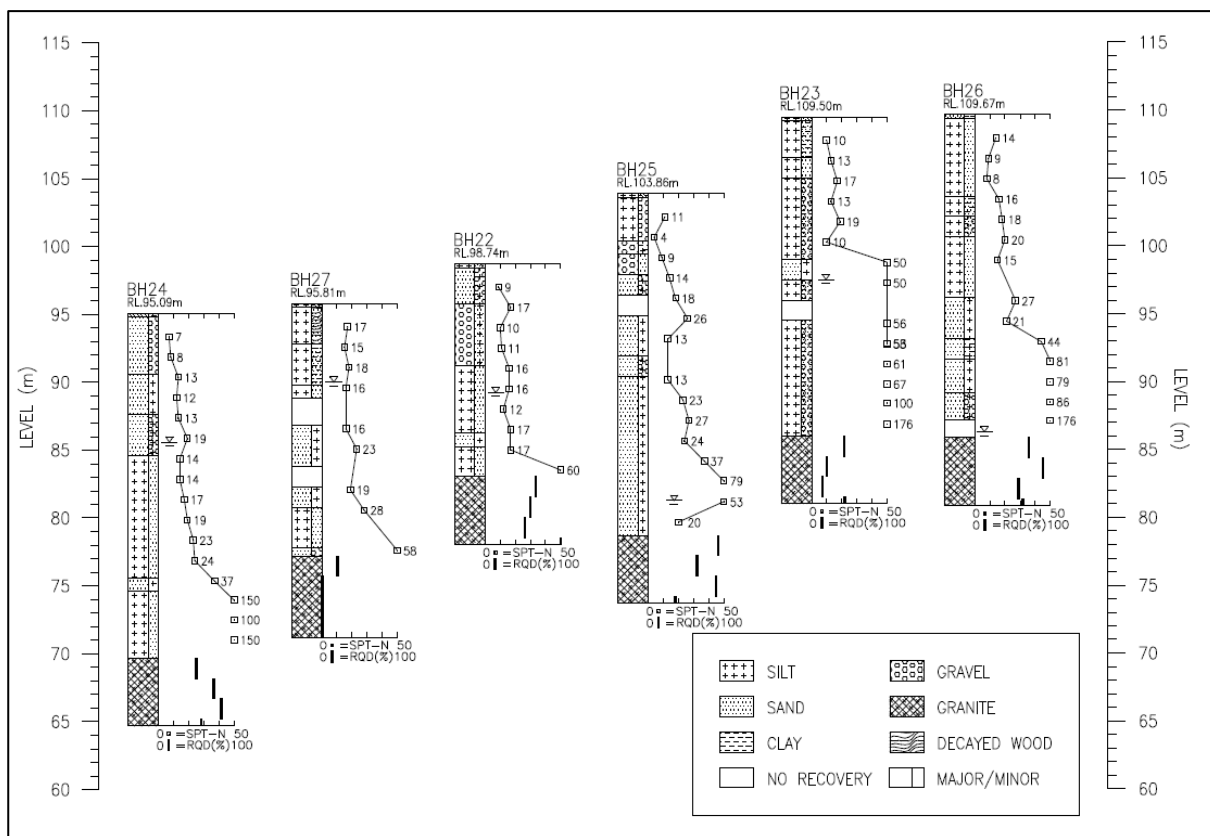

Figure 6. Borehole profiles at Site B.

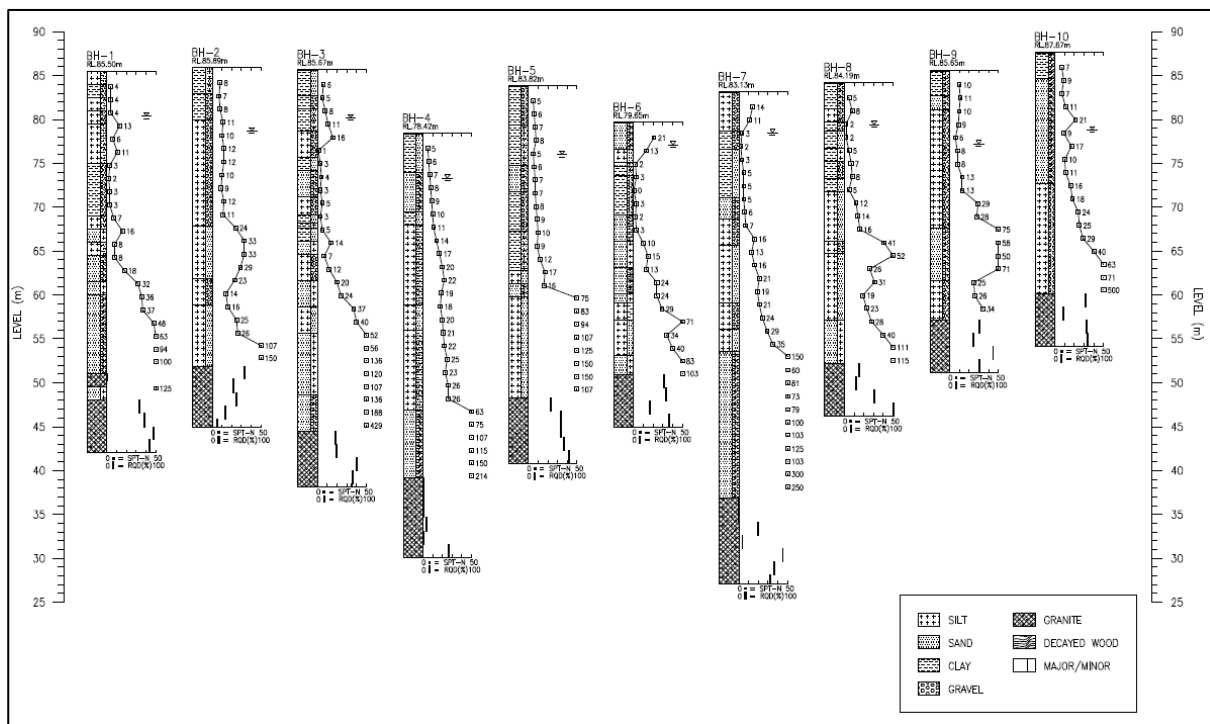

Figure 7. Borehole profiles at Site C.

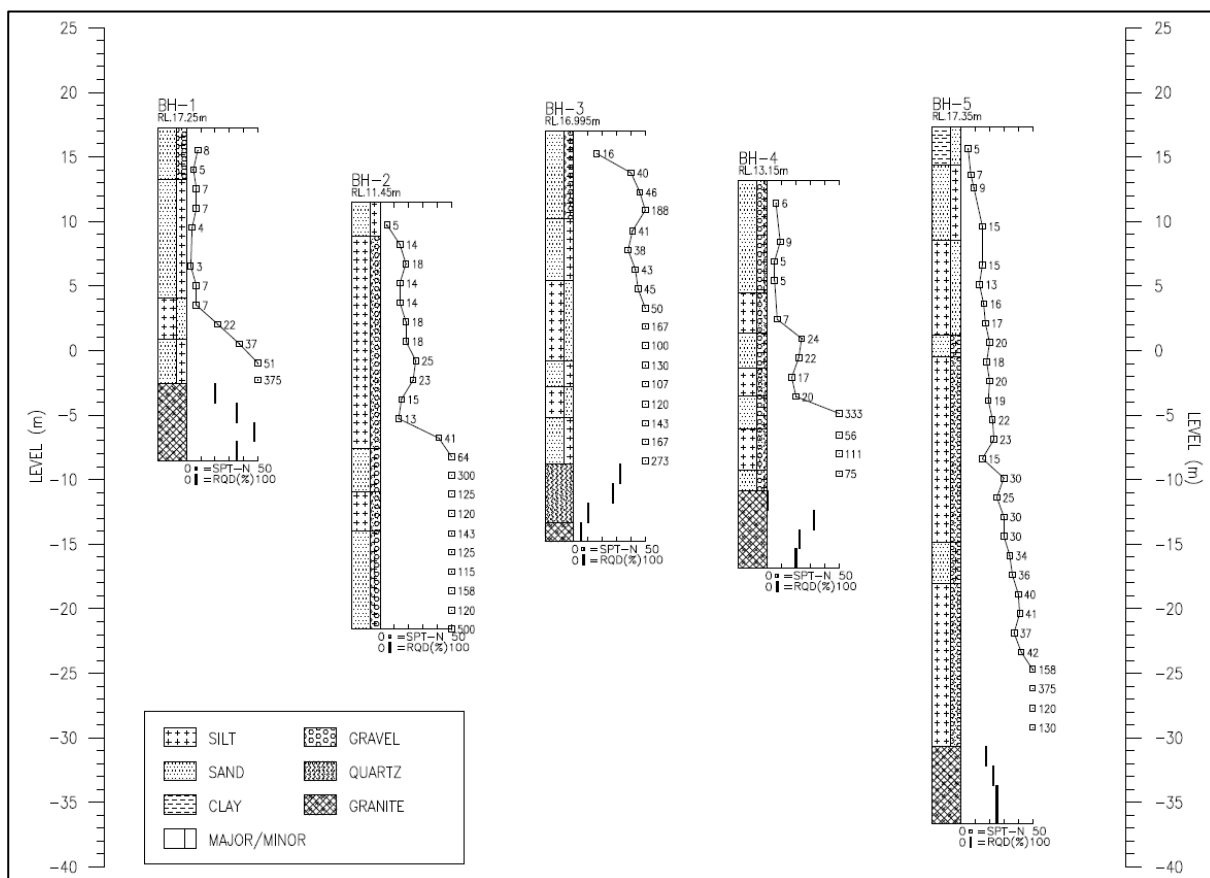

Figure 8. Borehole profiles at Site D.

Details of the jack-in pile adopted and tested for the four sites are summarised below:

a) Site A

PILE TYPE	WORKING LOAD	TERMINATION CRITERIA*
φ450mm spun pile (thickness – 100mm)	1520kN	Jacked to 2.5 times working load with holding time of 30 seconds
φ500mm spun pile (thickness – 110mm)	2300kN	

b) Site B

PILE TYPE	WORKING LOAD	TERMINATION CRITERIA*
φ450mm spun pile (thickness – 80mm)	1600kN	Jacked to 2.1 times working load with holding time of 60 seconds
φ500mm spun pile (thickness – 90mm)	2100kN	
φ600mm spun pile (thickness – 100mm)	2800kN	

c) Site C

PILE TYPE	WORKING LOAD	TERMINATION CRITERIA*
φ450mm spun pile (thickness – 100mm)	1900kN	Jacked to 2.0 times working load with holding time of 30 seconds
φ500mm spun pile (thickness – 110mm)	2300kN	
φ600mm spun pile (thickness – 110mm)	3000kN	

d) Site D

PILE TYPE	WORKING LOAD	TERMINATION CRITERIA*
φ400mm spun pile (thickness – 100mm)	1700kN	Jacked to 2.0 times working load with holding time of 30 seconds
φ500mm spun pile (thickness – 110mm)	2300kN	
φ600mm spun pile (thickness – 110mm)	3000kN	

*The maximum jack-in pressure with holding time of 30 seconds is carried out for a minimum of two (2) cycles.

Note: It can be observed that different termination criteria were adopted for the four different sites with maximum jack-in pressure ranging from 2.0 to 2.5 and holding time varying from 30-seconds to 60-seconds. The reasons behind this is due to technical research carried out by the Authors to find the most optimum maximum jack-in pressure and to satisfy other parties (e.g. Clients, Structural Engineers, etc.) who are not familiar with the relatively new jack-in pile foundation system. As such, sometimes more conservative maximum jack-in pressure and

holding time is adopted for certain projects. Generally, maximum jack-in pressure to 2.0 times working load with a holding time of 30 seconds is sufficient (2 cycles). The implication of the difference in maximum jack-in pressure and holding time is not expected to affect the findings in this paper.

Results of the pile load tests are summarised in Table 4. All the piles selected for testing at the above four sites passed with settlement within allowable limits.

Table 4. Summary of pile load test results.

Pile Diameter (mm)	Pile Length (m)	Settlement (mm)		Remarks
		Working Load	2*Working Load	
Site A				
450*	10.5	6.36	12.89	-
500	37.0	4.53	11.89	-
500*	20.6	9.23	20.46	20m preboring
Site B				
450	12.0	3.04	6.96	-
500	17.7	7.82	17.81	-
500	22.6	5.39	12.77	-
500	9.5	5.41	15.03	-
500*	6.5	8.32	19.73	-
600	17.7	4.82	12.16	-
600*	20.7	5.57	13.05	-
600	14.5	9.88	21.28	-
Site C				
450	27.6	8.88	18.21	-
450*	32.5	6.72	15.93	-
500	24.7	8.85	22.22	Instrumented (PTP-1)
600	27.0	8.62	17.67	-
600	17.5	7.35	16.37	-
600	23.0	7.99	20.75	Instrumented (PTP-2)
600*	21.4	7.37	17.30	Instrumented (PTP-3)
Site D				
400	7.5	9.23	19.99	-
500*	16.5	6.41	21.83	-
600*	34.8	8.48	16.76	Instrumented (PTP-1) Pile tested up till 2.5*WL. Settlement at 2.5*WL: 23.84mm. Residual settlement after unloading from 2.5*WL: 5.48mm.

600	25.5	7.46	15.38	Instrumented (PTP-2) Pile tested up till 2.5*WL. Settlement at 2.5*WL: 21.90mm. Residual settlement after unloading from 2.5*WL: 6.33mm.
-----	------	------	-------	--

*Plots of load-settlement results shown in Figures 9 to 12.

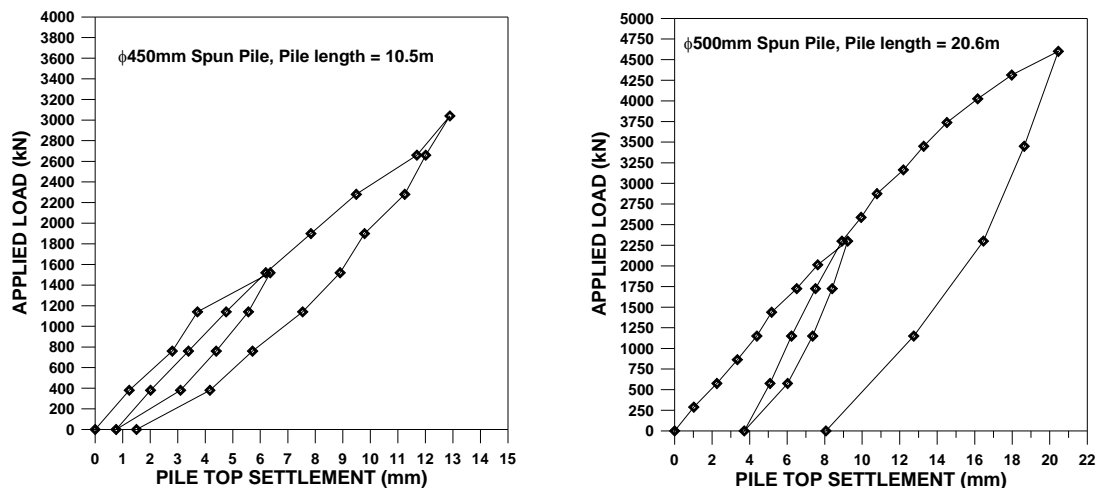

Figure 9. Load-settlement results of pile load test at Site A.

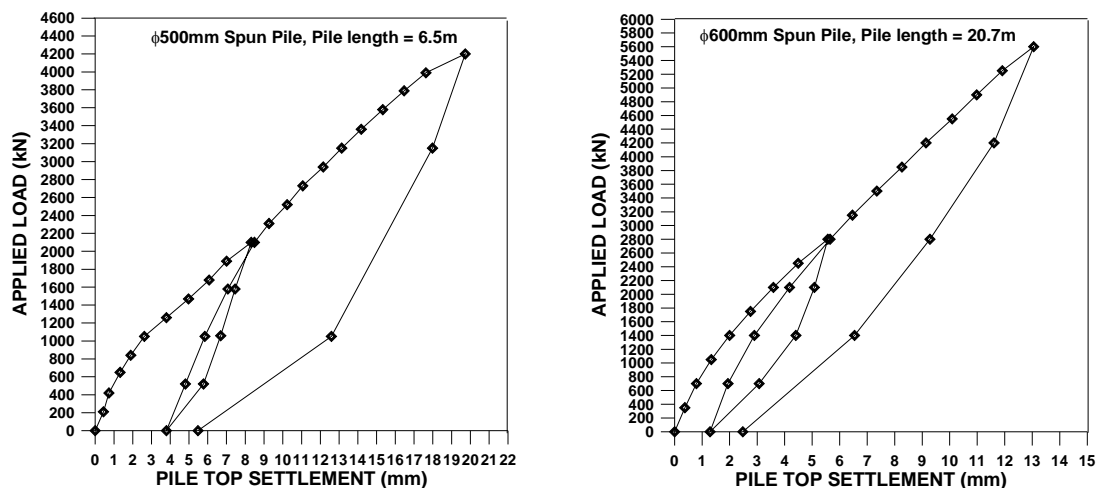

Figure 10. Load-settlement results of pile load test at Site B.

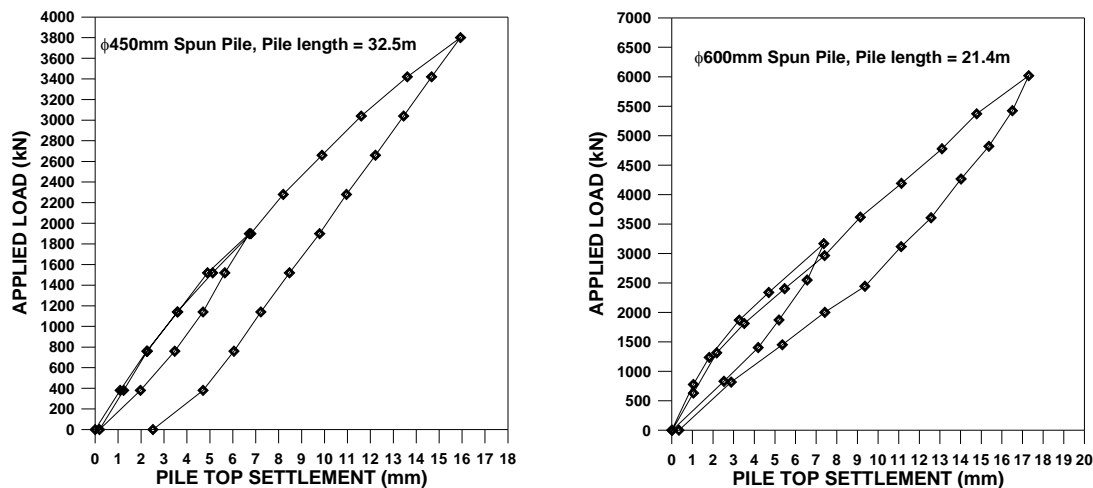

Figure 11. Load-settlement results of pile load test at Site C.

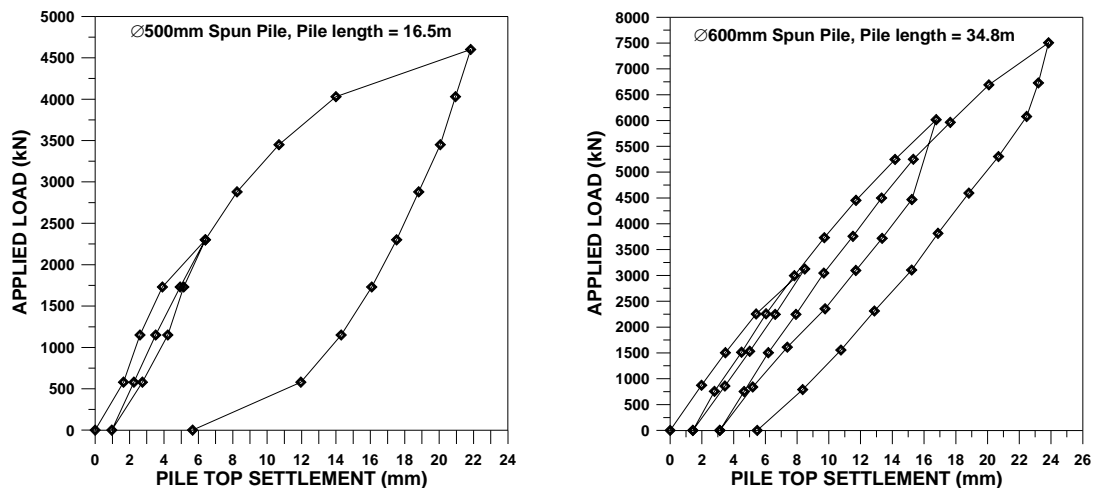

Figure 12. Load-settlement results of pile load test at Site D.

From the above pile load test results, the following is observed:

- Pile performance is satisfactory for pile lengths as short as 6.5m with settlement at working load and two times working load of 8.32mm and 19.73mm respectively.
- Pile performance is satisfactory for piles where preboring has been carried out. This demonstrates the validity of the assumption that the geotechnical capacity of the pile is a function of the jack-in force during pile installation.
- The termination criterion adopted of jacking to two times of working load (WL) with holding time of 30 seconds is adequate. In fact, from the load test results (Figures 9 to 12), there is room for possible optimization, as the piles can support up to two times working load without showing signs of plunging failure. Two of the piles tested up to 2.5*WL in Site D also demonstrate that the geotechnical capacity of the pile is more than 2.5*WL as the residual settlement after unloading from the maximum test load is relatively small (5.48mm and 6.33mm respectively).

For Site C, rock socketed bored piles were also constructed and tested and the test results are summarised below:

- a) $\phi 750$ mm bored pile – Pile length: 23.8m with 0.9m rock socket
Working Load (WL): 3880kN
Settlement at WL: 6.86mm
Settlement at 2*WL: 44.14mm
- b) $\phi 1200$ mm bored pile – Pile length: 28.7m with 0.5m rock socket
Working Load (WL): 9800kN
Settlement at WL: 11.45mm
Settlement at 2*WL: 17.02mm

Based on the above, it is interesting to note that the settlement performances of the rock socketed bored piles and spun piles are comparable. Therefore, combination of two different types of foundations is acceptable provided that the foundations are designed and constructed properly.

4.0 RECOMMENDED TERMINATION CRITERION FOR JACK-IN PILES INSTALLATION IN WEATHERED GRANITE

Based on the above case histories where the performance of the jack-in pile foundation is satisfactory with all the piles tested achieving a minimum of two times the pile working load, the recommended termination criterion for jack-in piles in weathered granite formation are as follows:

“The termination criterion is to jack the pile to 2.0 times of the design load for a minimum of two cycles. The corresponding pressure has to be held for minimum 30 seconds with settlement not exceeding 2mm or unless otherwise specified by the Engineer.”

Questions often arise with regards to the adequacy of maintaining the jack-in pressure for the relatively short duration of 30 seconds only where long-term settlement of the pile cannot be verified. However, it should be noted that the termination criterion has the objective of installing the pile in order to achieve the required geotechnical capacity and is not for settlement verification. This is similar to installation of driven piles where the termination (or “set”) criterion of piles is determined to ensure adequate geotechnical capacity and long-term settlement of the piles definitely cannot be assessed during pile driving. For bored piles, verification of pile capacity and settlement characteristics depends solely on load tests.

The designer is still responsible for assessing the adequacy of the installed pile length based on available subsurface investigation (SI) information. For example, achieving the required

termination criterion on a thin layer of intermediate hard layer/boulder which is followed by very soft soil below it is not adequate for piles where end-bearing consists of a significant proportion of its capacity. The pile should terminate in a competent stratum to ensure the load-carrying capacity of the pile is adequate for long-term within acceptable serviceability limits. This is similar to conventional driven piles design practice.

Therefore, similar to conventional pile design, the termination criterion for jack-in piles should be subjected to verification via a maintained load test to ensure adequate geotechnical capacity within acceptable serviceability limits. However, the jack-in pile offers considerable advantage over conventional driven and bored piles system as shown in Table 5.

It can be seen from Table 5 that the jack-in pile foundation system offers advantages compared to other piling systems as every pile installed is somewhat being verified that it can sustain at least two times the pile working load without suffering plunging (geotechnical) failure. This is supported by research findings of Deeks, White & Bolton (2005) and case histories discussed earlier.

Table 5. Comparison of different types of piling systems.

	JACK-IN PILE	DRIVEN PILE	BORED PILE
Loading rate during pile installation	Slow	Very fast	N.A.
Termination criteria	Static (pseudo) load imposed onto pile head	Dynamic load imposed onto pile head	Based on SI information
Variables affecting efficiency of load transfer during pile installation	<ol style="list-style-type: none"> 1. Hydraulic system of jacks 2. Calibration of pressure gauge 	<ol style="list-style-type: none"> 1. Efficiency of hammer, helmet, etc. 2. Hammer drop height 3. Cushion properties 4. Eccentricity of pile/hammer 	N.A.
Verification of geotechnical capacity during installation	Relatively straightforward as loading rate is slow	Indirect verification based on dynamic analysis. Often unreliable.	N.A.
Probability of pile damage during installation	Low	High	Depends on workmanship

Driven piles can only offer indirect verification which depends on a lot of external factors such as hammer performance, drop height, etc. while no such benefits are offered by bored piles. Therefore, it is proposed to adopt a less conservative set of factors of safety for jack-in pile design to Eurocode 7 (EC7) due to the following rationale:

- a) High quality research has proven that the geotechnical capacity and stiffness of jack-in piles is higher compared to conventional driven piles.
- b) Case histories have demonstrated that the current approach (i.e. design based on driven piles correlations) will tend to underestimate jack-in pile geotechnical capacity.
- c) The degree of risks associated with jack-in piles is lower as every pile is tested somewhat to verify its geotechnical capacity during installation.

It must be pointed out that the factors of safety will need to be adjusted once more instrumented pile load test results are available (and properly interpreted) to derive more appropriate correlations of shaft friction and end-bearing for jack-in piles.

5.0 CONCEPT FOR APPLICATION OF EC7 TO GEOTECHNICAL DESIGN OF JACK-IN PILE FOUNDATION UNDER COMPRESSION LOAD IN MALAYSIA

The application of EC7 for jack-in pile design in Malaysia needs rationalization and harmonization with current established local practice that has been successfully adopted since the introduction of large size, high capacity jack-in piles to Malaysia in the 1990s.

Similar to other types of pile foundation under compression load, the following are the main criteria that require rationalization and harmonization for the application of EC7 in Malaysia for the geotechnical design of jack-in pile foundations under compression load, as listed in items (a) to (d), while additional items specifically for jack-in piles are stated in item (e):

- a) Understanding of the indirect comparison of load factors, partial factors of safety and other model factors used in EC7 with conventional Factor of Safety which local engineers are familiar with.
- b) The transformation of the current Factors of Safety (FOS) on shaft (F_s) and base (F_b) and global FOS (F_g) on total capacity into partial factors and other model factors to be used in the Malaysian National Annex. The suggested Malaysian National Annex should be compared with the EC7 Annex A (normative) and the UK National Annex to the EC7 (UK-NA).
- c) A clear distinction between the partial factors on resistance for shaft and base which are mobilized at different magnitudes of displacement.
- d) Requirements for pile testing, especially static load tests and dynamic load tests on preliminary piles (sacrificial piles) that are to be loaded to failure and also on working piles which are to be loaded to a designed test load.
- e) Since every jack-in pile is jacked to two (2) times the design load (e.g. working load) or more, and held for 30 seconds to record settlement for at least two (2) cycles, this is similar to carrying out “static” load tests in a very short holding time. Therefore in determining the design approach for jack-in piles, it should take into consideration of

EN1997-1, Clause 7.6.2.2: “Ultimate compressive resistance from static load tests”.

5.1 The Concept of Different Partial Factors of Safety for Shaft and Base

In conventional design practiced in Malaysia, the Factors of Safety (FOS) normally used in static evaluation of pile geotechnical capacity are partial FOS on shaft (F_s) and base (F_b) respectively; and global FOS (F_g) on total capacity. The lower geotechnical capacity obtained from both methods is adopted as the allowable geotechnical capacity

For **Jack-in Pile** (under Compression Load):

$$Q_{ag} = \frac{Q_{su}}{F_s} + \frac{Q_{bu}}{F_b} = \frac{Q_{su}}{1.5} + \frac{Q_{bu}}{3} \quad (\text{eq.1})$$

$$Q_{ag} = \frac{Q_{su} + Q_{bu}}{F_g} = \frac{Q_{su} + Q_{bu}}{2} \quad (\text{eq.2})$$

Note: Use the lower of Q_{ag} obtained from eq. 1 and eq. 2 above.

In view of the above, it is important that when drafting the Malaysian National Annex for EC7, the partial factors of resistance should be in line with current local practice. Different partial FOS should be used for shaft and base as the displacement required to mobilize the shaft and base are different as reported in many literatures on pile behaviour.

5.2 Suggestions on Model Factor in Malaysian National Annex of EC7 for Geotechnical Design of Jack-in Piles under Compression Load

EC7 and UK-NA generally allow lower partial factors which yielded a lower “indirect” FOS if testing on preliminary piles to ultimate resistance is carried out on site to verify the load capacity. This is evident on the reduction of model factor from 1.4 to 1.2 if there is a preliminary pile static load test which is loaded to unfactored ultimate resistance (e.g. failure load).

When adopting the design approach as in EN1997-1, 7.6.2.3(8), it is necessary to specify the value of the model factor to be used. EC7 and UK-NA do not have recommended values of model factors specifically for jack-in piles.

In suggesting the model factor and partial factors in the Malaysian National Annex (MY-NA) for jack-in piles, the following considerations are made:

- a) Since every jack-in pile during installation is jacked (loaded) to two (2) times the design load or more, and held for 30 seconds to record settlement for at least two (2) cycles, this is similar to carrying out a “static” load test in a very short holding time. Despite not being exactly the same as a static load test, however, compared to other

pile types (e.g. driven piles, bored piles and micropiles) which are not “test loaded” at all during installation, the quality control and verification of load capacities for jack-in piles is more rigorous and more assured than other pile types. Therefore, the suggested model factor value should be smaller than that of driven piles and bored piles in line with the concept of EC7 allowing lower model factors with more testing.

- b) For consistency in design, it is suggested that the partial factors for resistance (shaft, base and combined) in jack-in piles should follow those of driven piles when adopting a design approach as in EN1997-1, 7.6.2.3(8)

Table 6 lists the suggested Model Factors for jack-in pile to be used in MY-NA. Generally, the suggested value is only about 7.1% to 8.3% lower than the Model Factor in UK-NA.

Table 6. Comparison of Model Factor for Suggested MY-NA with EC7 and UK-NA

Model Factor For Jack-in Pile	Suggested MY-NA	Model Factors	EC7	UK-NA
WITHOUT static load test to Ultimate Capacity	1.3	Without static load test to Ultimate Capacity	>1.0	1.4
WITH static load test to Ultimate Capacity	1.1	With static load test to Ultimate Capacity	>1.0	1.2

5.3 Comparison of EC7 using Model Factor with Conventional Factor of Safety

A jack-in pile is categorized as a displacement pile similar to a driven pile except in the installation method. Therefore, it is logical to compare with driven piles the factors of safety in design. This section converts partial factors for actions, soil materials, resistance and also model factors for driven piles used in EC7 to the conventional FOS which local engineers are familiar with for comparison despite the conversion perhaps being indirect with assumptions on the ratio of permanent load (e.g. dead load) to variable load (e.g. life load). Design Approach 1 and Design Approach 2 are referred for comparison.

Tables 7 and 8 summarise the partial factors for actions, soil materials and resistance for driven pile extracted from EN1997-1:2004 Annex A and UK national Annex to EN1997-1:2004 respectively. UK National Annex (UK-NA) only applies Design Approach 1 (as stated in NA to BS EN 1997-1:2004, page 2).

Complying with EN1997-2004, 2.4.1(6), UK-NA also recommends a model factor to be applied to resistances calculated using characteristic values of soil properties. The value of the model factor for driven piles should be **1.4**, except that it may be reduced to **1.2** if the resistance is verified by a static load test taken to the calculated, unfactored ultimate resistance.

Major differences between Annex A in the EC7 and UK-NA are the partial factors used for shaft, base and also total/combined resistance (capacity). The UK-NA introduces lower partial factors if there is explicit verification of the Serviceability Limit State (SLS) with the following requirements:

- a) if serviceability is verified by load tests (preliminary and/or working) carried out on more than 1% of the constructed piles to loads not less than 1.5 times the representative load for which they are designed, OR
- b) if settlement is explicitly predicted by a means no less reliable than in (a), OR
- c) if settlement at the serviceability limit state is of no concern

Table 7. Summary of Partial Factors for Actions, Soil Materials and Resistance extracted from EN1997-1:2004 Annex A.

			Design Approach 1							Design Approach 2		
			Combination 1			Combination 2 – piles & anchors				Combination 1		
			A1	M1	R1	A2	M1 or M2	R4	A1	M1	R2	
Actions	Permanent	Unfav	1.35			1.00				1.35		
		Fav	1.00			1.00				1.00		
	Variable	Unfav	1.50			1.30				1.50		
Soil	tan ϕ'			1.00			1.00	1.25			1.00	
	Effective cohesion			1.00			1.00	1.25			1.00	
	Undrained strength			1.00			1.00	1.40			1.00	
	Unconfined strength			1.00			1.00	1.40			1.00	
	Weight density			1.00			1.00	1.00			1.00	
Driven piles	Base				1.00				1.30			1.10
	Shaft (compression)				1.00				1.30			1.10
	Total / combined				1.00				1.30			1.10

A *model factor* should be applied to the shaft and base resistance calculated using characteristic values of soil properties by a method complying with EN1997-1, 2.4.1(6). The value of the *model factor* should be 1.4, except that it may be reduced to 1.2 if the resistance is verified by a static load test taken to the calculated, unfactored ultimate resistance.

(Extracted from NA to BS EN 1997-1:2004, page 11)

For the easy reference of Malaysian engineers who are familiar with the conventional Factor of Safety (FOS), the Authors had calculated the “indirect” FOS associated with each design approach listed in EC7 (Table 7) and UK-NA (Table 8) for comparison. Table 9 summarises the “indirect” FOS on shaft, base and combined resistance for different design approaches in the EC7 and UK-NA. The ratio of permanent load (e.g. dead load) to variable load (e.g. life load, etc.) is taken as 8:2 when calculating the “indirect” FOS. Generally, the “indirect” FOS of driven piles for EC7 and UK-NA ranges from 1.65 to 2.52 for combined capacity compared to the current Malaysian practice of 2.0. The “indirect” FOS for shaft capacity ranges from 1.65 to 2.23 while the “indirect” FOS for base capacity ranges from 1.65 to 2.52.

Table 8. Summary of Partial Factors for Actions, Soil Materials and Resistance extracted from UK National Annex EN1997-1:2004.

Design Approach 1											
			Combination 1			Combination 2 – piles and anchors					
						WITHOUT explicit verification of SLS ^{A)}			WITH explicit verification of SLS ^{A)}		
			A1	M1	R1	A2	M1	R4	A1	M1	R4
Actions	Permanent	Unfav	1.35			1.00			1.00		
		Fav	1.00			1.00			1.00		
	Variable	Unfav	1.50			1.30			1.30		
Soil	tan ϕ'			1.00			1.00			1.00	
	Effective cohesion			1.00			1.00			1.00	
	Undrained strength			1.00			1.00			1.00	
	Unconfined strength			1.00			1.00			1.00	
	Weight density			1.00			1.00			1.00	
Driven piles	Base				1.00			1.70			1.50
	Shaft (compression)				1.00			1.50			1.30
	Total / combined				1.00			1.70			1.50
<p>^{A)} The lower partial factor of safety in R4 may be adopted</p> <ul style="list-style-type: none"> a) if serviceability is verified by load tests (preliminary and/or working) carried out on more than 1% of the constructed piles to loads not less than 1.5 times the representative load for which they are designed, OR b) if settlement is explicitly predicted by a means no less reliable than in (a), OR c) if settlement at the serviceability limit state is of no concern <p>A <i>model factor</i> should be applied to the shaft and base resistance calculated using characteristic values of soil properties by a method complying with EN1997-1, 2.4.1(6). The value of the <i>model factor</i> should be 1.4, except that it may be reduced to 1.2 if the resistance is verified by a static load test taken to the calculated, unfactored ultimate resistance.</p> <p>(Extracted from NA to BS EN 1997-1:2004, page 11)</p>											

Table 9. Summary of “Indirect” Factors of Safety (FOS) calculated from EN1997-1:2004 Annex A and the UK National Annex EN1997-1:2004.

Methodology / Indirect Factor Of Safety (FOS) values (for Comparison with Conventional Method)		DA1-C1	DA1-C2	DA2-C1	DA1-C2 UK-NA WITHOUT explicit verification of SLS ^(A)	DA1-C2 UK-NA WITH explicit verification of SLS ^(A)
Model Factor =1.4						
Driven Pile (Compression)	Base FOS	1.93	1.93	2.13	2.52	2.23
	Shaft FOS	1.93	1.93	2.13	2.23	1.93
	Total/Combined FOS	1.93	1.93	2.13	2.52	2.23
Model Factor =1.2						
Driven Pile (Compression)	Base FOS	1.66	1.65	1.82	2.16	1.91
	Shaft FOS	1.66	1.65	1.82	1.91	1.65
	Total/Combined FOS	1.66	1.65	1.82	2.16	1.91
Where :						
DA1-C1 = EN1997-1:2004 Design Approach 1 – Combination 1						
DA1-C2 = EN1997-1:2004 Design Approach 1 – Combination 2 – Piles and Anchors						
DA2-C1 = EN1997-1:2004 Design Approach 2 – Combination 1						
DA1-C2 UK-NA = UK National Annex to EN1997-1:2004 Design Approach 1 – Combination 2 – Piles and Anchors						
Note :						
1. Permanent (Dead Load) to Variable (Life Load) ratio of 80%:20% is assumed in this table.						
2. For DA1-C1 and DA2-C1; the Average FOS on Total Load =1.38;						
3. For DA1-C2-Pile and Anchors; the Average FOS on Total Load = 1.06						

5.4 Suggestions on Partial Factors for Malaysian National Annex of EC7 for Jack-in Piles under Compression Load

When suggesting partial factors for jack-in piles for the Malaysian National Annex (MY-NA) to the EC7, it is important to take into consideration the following factors that are similar to other types of pile foundation (e.g. driven piles and bored piles):

- a) The partial factors should be in line with current partial factors of safety (FOS) on shaft (F_s) and base (F_b) and the global FOS (F_g) on total capacity that have been extensively accepted and used in Malaysia.
- b) Clear distinctions between partial factors of safety for shaft and base which are mobilized at different strains (displacement).
- c) Requirements for pile testing, especially static and dynamic load tests on preliminary piles (sacrificial piles) which are to be loaded to failure and also working piles which are to be loaded to the designed test load.
- d) To adopt a Model Factor for MY-NA as described in Section 5.2. A Model Factor of 1.3 and 1.1 corresponding to design without and with static load tests to ultimate capacity respectively will be adopted.
- e) Adopt the EC7 concept of allowing lower partial factor if more verification tests (e.g. static or dynamic load tests) are carried out on site.
- f) To verify the suggested partial factors with actual case histories to review the reliability of the suggested values. More case histories are needed before the values of partial factors for the Malaysian National Annex can be finalized.
- g) Complying to methodology of EN1997-1, 7.6.2.3(8), the characteristic values may be

obtained by calculating:

$$R_{b;k} = A_b q_{b;k} \quad \text{and} \quad R_{s;k} = \sum_j A_{s;j} \cdot q_{s;j;k} \quad (7.9)$$

where $q_{b;k}$ and $q_{s;j;k}$ are characteristic values of base resistance and shaft friction in the various strata, obtained from values of soil/rock parameters. $R_{b;k}$ and $R_{s;k}$ are characteristic base and cumulative shaft capacity (in kN).

NOTE : If this alternative procedure is applied, the values of the partial factors γ_b and γ_s recommended in the UK-NA Annex A may need to be corrected by a model factor larger than 1.0. The values of the model factor recommended in the UK-NA are 1.4 and 1.2 respectively and the suggested values of MY-NA for jack-in pile are 1.3 and 1.1 respectively (discussed in Section 5.2).

The EC7 also has other methodologies as follows:

- 7.6.2.2 Ultimate compressive resistance from static load tests
- 7.6.2.3 Ultimate compressive resistance from ground test results (except 7.6.2.3(8))
- 7.6.2.4 Ultimate compressive resistance from dynamic impact tests
- 7.6.2.5 Ultimate compressive resistance by applying pile driving formulae

However, these methodologies will not be covered in this paper and will have to be addressed separately in the future.

Table 10 summarises the Partial Factors for Actions, Soil Materials and Resistance suggested for Malaysian National Annex (MY-NA) to EN1997-1:2004. Generally, partial factors for *actions* and *soil materials* suggested for Malaysian National Annex (MY-NA) follow the driven pile values in UK National Annex. The suggested changes are on the partial factors for resistance. The partial factors suggested for resistance will be in line conceptually with Malaysian conventional partial factor of safety (FOS) on shaft (F_s) and base (F_b) and the global FOS (F_g) on total capacity. The partial factors for resistance in jack-in piles will be the same as those of driven piles as both are generally displacement type pile foundations and base capacity will not be reduced due to disturbance as in bored piles. When converting the partial factors to “indirect” FOS similar to Section 5.3, these values can be used to indirectly compare the conventional FOS commonly used in Malaysia.

Table 10. Summary of Partial Factors for Actions, Soil Materials and Resistance suggested for the Malaysian National Annex (MY-NA) EN1997-1:2004.

			Design Approach 1								
			Combination 1			Combination 2 – piles and anchors					
						WITHOUT explicit verification of SLS ^{B)}			WITH explicit verification of SLS ^{B)}		
			A1	M1	R1	A2	M1	R4	A1	M1	R4
Actions	Permanent	Unfav	1.35			1.00			1.00		
		Fav	1.00			1.00			1.00		
	Variable	Unfav	1.50			1.30			1.30		
Soil	tan ϕ'			1.00			1.00			1.00	
	Effective cohesion			1.00			1.00			1.00	
	Undrained strength			1.00			1.00			1.00	
	Unconfined strength			1.00			1.00			1.00	
	Weight density			1.00			1.00			1.00	
Driven piles	Base				1.10				1.9		1.8
	Shaft (compression)				1.00				1.5		1.0
	Total / combined				1.05				1.6		1.3
Jack-in Piles ^{C)}	Base				1.10				1.9		1.8
	Shaft (compression)				1.00				1.5		1.0
	Total / combined				1.05				1.6		1.3
<p>^{B)} The lower partial factor of safety in R4 may be adopted</p> <p>a) if serviceability is verified by static load tests (preliminary and/or working) carried out in accordance with the pile testing criteria listed in Table 12 of this paper (<i>MY-NA suggestion</i>), OR</p> <p>b) if settlement is explicitly predicted by a means no less reliable than in (a), OR</p> <p>c) if settlement at the serviceability limit state is of no concern</p>											
<p>For Driven Piles & Bored Piles, the model factor should be applied to shaft and base resistance calculated using characteristic values of soil properties by a method complying with EN1997-1, 2.4.1(6). The value of the model factor should be 1.4, except that it may be reduced to 1.2 if the resistance is verified by static load tests taken to the calculated, unfactored ultimate resistance (To follow NA to BS EN 1997-1:2004).</p>											
<p>^{C)} For Jack-in Piles, the model factor should be applied to shaft and base resistance calculated using characteristic values of soil properties by a method complying with EN1997-1, 2.4.1(6). The value of the model factor should be 1.3, except that it may be reduced to 1.1 if the resistance is verified by static load tests taken to the calculated, unfactored ultimate resistance.</p>											
<p>Irrespective of design approach adopted, proper and sufficient verification tests such as static load tests, dynamic load tests and sonic logging (for bored piles) should be carried out to verify the acceptance of the pile.</p>											

Irrespective of which design approach is adopted, sufficient and properly planned subsurface investigation (S.I.), including field and laboratory tests, should be carried out to obtain representative subsoil conditions and parameters. Proper full time supervision of S.I. is also

important to increase confidence levels in the information obtained.

The EC7 and UK-NA generally allow lower partial factors that yield lower “indirect” FOS if testing on preliminary piles to unfactored ultimate resistance is carried out on site to verify the load capacity. In addition, the UK-NA also allows lower values of partial factors of resistance if there is explicit verification of the Serviceability Limit State (SLS) by load tests (preliminary and/or working) carried out on more than 1% of the constructed piles to loads not less than 1.5 times the representative load for which they are designed. In summary, the fundamental approach of Eurocode 7 is with more load tests, the final “indirect” (FOS) could be lower compared to sites with fewer load tests.

In line with these two concepts, the jack-in pile system, in which every pile is in a way statically “load tested” to at least two (2) times the working load, would logically be allowed to have a lower “indirect” FOS compared to driven piles and bored piles.

Table 11 summarises the “indirect” FOS calculated from EN1997-1:2004 Annex A, UK-NA and MY-NA. Generally, the “indirect” FOS suggested for jack-in pile in the MY-NA ranges from 1.52 to 2.20 for combined capacity compared to the current Malaysian practice of 2.0. The “indirect” FOS for shaft capacity ranges from 1.17 to 2.07, while the “indirect” FOS for base capacity ranges from 1.67 to 2.62.

Table 11. Summary of “Indirect” Factors of Safety (FOS) calculated from EN1997-1:2004 Annex A, UK National Annex EN1997-1:2004 and the suggested Malaysian Annex EN1997-1:2004.

Methodology / Indirect Factor Of Safety (FOS) values (for Comparison with Conventional Method)		DA1-C1	DA1-C2	DA2-C1	DA1-C2 UK-NA WITHOUT explicit verification of SLS ^{A)}	DA1-C2 UK-NA WITH explicit verification of SLS ^{A)}	DA1-C1 MY-NA	DA1-C2 MY-NA WITHOUT explicit verification of SLS ^{B)}	DA1-C2 MY-NA WITH explicit verification of SLS ^{B)}
Model Factor =1.4							Model Factor =1.4		
Driven Pile (Compression)	Base FOS	1.93	1.93	2.13	2.52	2.23	2.13	2.82	2.67
	Shaft FOS	1.93	1.93	2.13	2.23	1.93	1.93	2.23	1.48
	Total/Combined FOS	1.93	1.93	2.13	2.52	2.23	2.03	2.37	1.93
Model Factor =1.3							Model Factor =1.3		
Jack-in Pile (Compression)	Base FOS	nil	nil	nil	nil	nil	1.97	2.62	2.48
	Shaft FOS	nil	nil	nil	nil	nil	1.79	2.07	1.38
	Total/Combined FOS	nil	nil	nil	nil	nil	1.88	2.20	1.79
Model Factor =1.2							Model Factor =1.2		
Driven Pile (Compression)	Base FOS	1.66	1.65	1.82	2.16	1.91	1.82	2.41	2.29
	Shaft FOS	1.66	1.65	1.82	1.91	1.65	1.66	1.91	1.27
	Total/Combined FOS	1.66	1.65	1.82	2.16	1.91	1.74	2.03	1.65
Model Factor =1.1							Model Factor =1.1		
Jack-in Pile (Compression)	Base FOS	nil	nil	nil	nil	nil	1.67	2.21	2.10
	Shaft FOS	nil	nil	nil	nil	nil	1.52	1.75	1.17
	Total/Combined FOS	nil	nil	nil	nil	nil	1.59	1.86	1.52
Where : DA1-C1 = EN1997-1:2004 Design Approach 1 – Combination 1 DA1-C2 = EN1997-1:2004 Design Approach 1 – Combination 2 – Piles and Anchors DA2-C1 = EN1997-1:2004 Design Approach 2 – Combination 1 DA1-C2 UK-NA = UK National Annex to EN1997-1:2004 Design Approach 1 – Combination 2 – Piles and Anchors							Where : DA1-C1 MY-NA = Suggested Malaysian National Annex to EN1997-1:2004 Design Approach 1 – Combination 1 DA1-C2 MY-NA = Suggested Malaysian National Annex to EN1997-1:2004 Design Approach 1 – Combination 2 – Piles and Anchors		
Note : 1. Permanent (Dead Load) to Variable (Life Load) ratio of 80%:20% is assumed in this table. 2. For DA1-C1 and DA2-C1; the Average FOS on Total Load =1.38; 3. For DA1-C2-Pile and Anchors; the Average FOS on Total Load = 1.06									

In the UK-NA, in order to satisfy the SLS, the load to be tested is only up to 1.5 times the representative load (e.g. working load*) (* this excludes piles with negative skin friction) compared to the approach commonly adopted in Malaysia where the working pile is loaded to 2.0 times the working load. In the suggested MY-NA, the same approach as the UK-NA is applied by adopting a test load for the working pile to 1.5 times the working load instead of the old practice of 2.0 times. Further details are explained in Tan, et al. (2009).

For jack-in pile to qualify using a model factor of 1.1, a preliminary (sacrificial) pile should be subjected to a static load test taken to the calculated, unfactored ultimate resistance as follows:

- Load to at least 2.5 times the design load or to the failure of the pile to try to obtain ultimate resistance of pile for shaft and base and to determine the settlement characteristic of the pile.
- Instrumentation is encouraged to allow proper verification of load-settlement behaviour in shaft and also base.
- Without SLT on preliminary pile to achieve ultimate resistance, a Model Factor of 1.3 should be used instead.

To fulfil the requirement “***WITH*** explicit verification of SLS” for MY-NA, the testing criteria for piles under compression load should satisfy items (1) and (2) stated below:

1) Static Load Test (SLT) on Working Pile:

- Load to 1.5 times design load. Acceptable settlement at pile cut-off level should be less than 10% of the pile diameter.^(I)
- Acceptable settlement at pile cut-off-level should not exceed 12.5mm^(II) at 1.0 time the representative load.
- Acceptable residual settlement at pile cut-off-level should not exceed 6.5mm^(II) after full unloading from 1.0 time the representative load.
- To fulfil criteria “with explicit verification of SLS^B” (as described in Table 10), the percentage (%) of constructed piles listed in Table 12 should be subjected to SLT (minimum one (1) pile).

Note:

^(I) adopt the “failure” criterion as in EC7 7.6.1.1 (3) “For piles in compression it is often difficult to define an ultimate limit state from a load settlement plot showing a continuous curvature. In these cases, settlement of the pile top equal to 10% of the pile base diameter can be adopted as the "failure" criterion”. However, for very long piles, elastic shortening will need to be taken into account as the elastic shortening of the long pile itself may reach 10% of the pile diameter and in this scenario, the ultimate load should be defined by the Engineer.

^(II) The value indicated serves as a preliminary guide. Geotechnical Engineer and Structural Engineer should specify the project-specific allowable settlement at 1.0xWL and residual settlement to suit the buildings and structures to be supported by the pile.

2) (A) High Strain Dynamic Load Test (DLT) on Pile:

- To fulfil the criterion “with explicit verification of SLS^B” (as described in Table 10), a minimum percentage (%) of constructed piles listed in Table 12 should be subjected to DLT^(III)

Note:

^(III) DLT can be omitted if it is technically not suitable to carry out DLT on the pile (e.g. a bored pile with capacity solely relying on rock socket, etc). Then, more SLT should be carried out.

OR

(B) Statnamic Load Test (sNLT) on Pile:

- To fulfil the criterion “with explicit verification of SLS^B” (as described in Table 10), a minimum percentage (%) of constructed piles listed in Table 12 should be subjected to sNLT^(IV)

Note :

^(IV)

- (i) sNLT can be omitted if it is technically not suitable to carry out sNLT on the pile (e.g. a bored pile with capacity solely relying on rock socket, etc). Then, more SLT should be carried out.
- (ii) Since the reliability of test results using sNLT lies between SLT and DLT, therefore, a higher percentage of tests are needed compared to SLT but a lower percentage compared to DLT

In the event that the percentage (%) of SLT has to be increased or reduced due to the type of foundation system selected or the individual project’s nature, the required percentage of DLT should be adjusted accordingly. Table 12 lists the recommended percentage of testing to be carried out on the constructed piles to fulfil the criterion “**WITH** explicit verification of SLS”. The Authors also cross-checked the suggested percentage with 16 project sites that had been successfully completed and randomly selected by the Authors to verify that the recommended percentage is in order.

Table 12. Recommended percentage (%) of constructed piles to be tested to fulfil the criterion of “WITH explicit verification of SLS” in suggested MY-NA.

Options	% of Constructed Piles to be Tested to Fulfil Criteria of “WITH explicit verification of SLS”			
	Must Include		Either	Either
	SLT	AND	DLT	sNLT
1	> 0.2%		> 1.0%	≥ 0.5%
2	> 0.1%		> 2.5%	≥ 1.2%
3	> 0.05%		> 5.0%	≥ 2.5%
4 (Especially for bored /barrette piles where its capacity is mainly derived from rock socket friction)	> 0.3%	NIL	NIL	

Note: In all cases, the following minimum numbers of SLTs should be carried out:

1. Minimum one (1) for total piles < 500.
2. Minimum two (2) for 500 ≤ total piles < 1000.
3. Minimum three (3) for total piles ≥ 1000.

Even for sites “WITHOUT explicit verification of SLS” for the MY-NA, the design engineer still need to carry out necessary testing of the piles on site despite not being up to the percentage (%) specified in Table 12 to ensure safety.

6.0 COMPARISON OF SUGGESTED DESIGN METHODOLOGY WITH LOAD TEST RESULTS

One of the results of maintained load tests from Site D (φ500mm spun pile) described in Section 3.2 is further analysed and compared with the design methodologies of the EC7 using model and partial factors of the EC7, UK-NA and the suggested MY-NA. Load test results for that particular pile are chosen as the load-settlement curve shows some sign of the pile approaching ultimate capacity (Figure 12). As the pile did not reach ultimate capacity, Chin’s method (Chin, 1970) is used to determine the ultimate capacity of the pile. Ultimate capacity determined using Chin’s method tends to be higher compared to other methods such as Davisson, Brinch Hansen, De Beer, etc. (Fellenius, 1990) and therefore, the ultimate capacity determined using Chin’s method for the φ500mm spun pile from Site D is further downgraded by 30% to err on the safe side.

Generally, other piles studied in this paper still demonstrate relatively linear load-settlement behaviour (even for piles tested up to 2.5 times working load) and determination of ultimate capacity using the interpolation method of Chin (1970) will lead to larger ultimate capacity. The ultimate capacity determined using Chin’s method (and further downgraded by 30%) for the φ500mm spun pile from Site D is conservative, as it is one of the few piles out of a total of 22 piles tested which shows some sign of reaching ultimate capacity.

From the load test results, the ultimate capacity for the φ500mm spun pile from Site D is approximately 7000kN as shown in Figure 13. The ultimate capacity used for comparison purposes in this paper (after downgrading 30%) is 4900kN.

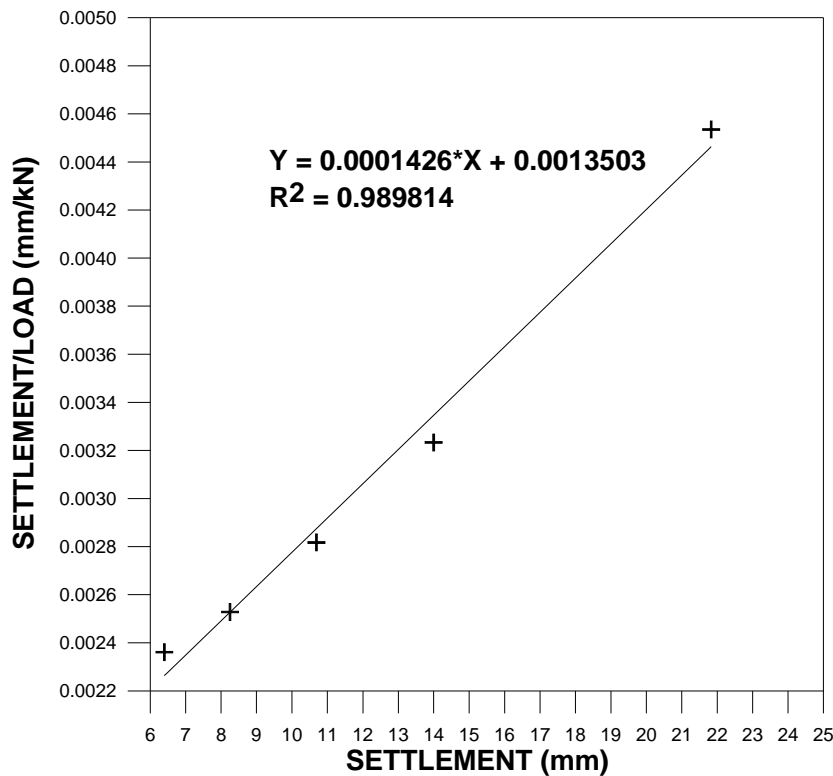

Figure 13. Chin's plot for $\phi 500\text{mm}$ spun pile (Site D).

Figure 14 compares the results of pile capacities determined using the EC7 using model and partial factors of the EC7, UK-NA and the suggested MY-NA together with interpreted ultimate capacity determined using Chin's method (downgraded by 30%). Figure 15 shows the ratio of allowable capacity calculated using various methodologies over the allowable capacity calculated using the Malaysian conventional design.

As observed from Figures 14 and 15, methodologies DA1-C1 and DA1-C2 of EC7 are generally more optimistic compared to the UK-NA and the suggested MY-NA. The suggested MY-NA for "WITHOUT explicit verification of SLS" will produce an allowable pile capacity which matches with Malaysian conventional design ($K_{su} = 2.5$ and $K_{bu} = 300$). However, static load test results have shown that the current approach is conservative. For DA1-C2 of MY-NA (with explicit verification of SLS) which calculated the highest allowable pile capacity, the value still falls within the acceptable load and deformation limits, as proven in the static load test results. Therefore, the suggested MY-NA encourages the designer to carry out more static load tests in order to adopt higher allowable pile capacity.

Another observation worth noting is that the calculated pile capacity using the Malaysian conventional design, which is primarily based on experience from driven piles, will tend to underestimate the capacity of jack-in piles. This is expected based on the discussions in Section 3.0. Therefore, for jack-in piles in weathered granite, the maximum jack-in pressure sustained for 30 seconds with settlement not exceeding 2mm will give a more accurate indication of the pile capacity.

In summary, load test results indicated the suggested MY-NA model and partial factors are acceptable and are conservative. The current conservatism is warranted for the initial application of the EC7 and to ensure safety. The model and partial factors can be revised once

more pile load test results are compiled and more experience is gained in the application of the EC7 in the design of jack-in piles.

7.0 CONCLUSION

High capacity jack-in pile foundations with working load up to 3000kN have been successfully adopted for high-rise buildings of up to 45-storeys in Malaysia. The popularity of jack-in pile foundation systems especially for construction works in urban areas, is due to their relatively lower noise and lower vibration compared to conventional systems such as driven piles. The following findings are obtained based on the results of static load tests carried out, and various research results published:

- a) Due to the nature of pile installation using the jack-in system where less cycling loading is induced during installation, mobilized shaft friction in jack-in piles is expected to be higher compared with conventional driven piles.
- b) The jack-in pile is expected to mobilize higher end-bearing resistance at working load compared to driven piles as the magnitude of residual pressures is expected to be greater.
- c) Based on load test results where the piles are tested up to at least two times their working load, the following termination criterion for jack-in piles in weathered granite is recommended:
“The termination criterion is to jack the pile to 2.0 times the design load for a minimum of two cycles. The corresponding pressure has to be held for a minimum of 30 seconds with settlement not exceeding 2mm or unless otherwise specified by the Engineer.”
- d) A review of static load test results has indicated that jack-in pile capacity calculated using equations derived primarily for driven piles will tend to be underestimated.
- e) Model, partial and correlation factors for the Malaysian National Annex (MY-NA) in the application of the EC7 based on Malaysian experience are proposed. The proposed factors had taken into consideration experience gained in Malaysia on the performance of jack-in pile foundations and adjusted to ensure a smooth transition from current Malaysian practice based on working state principles to the limit state design of the EC7.

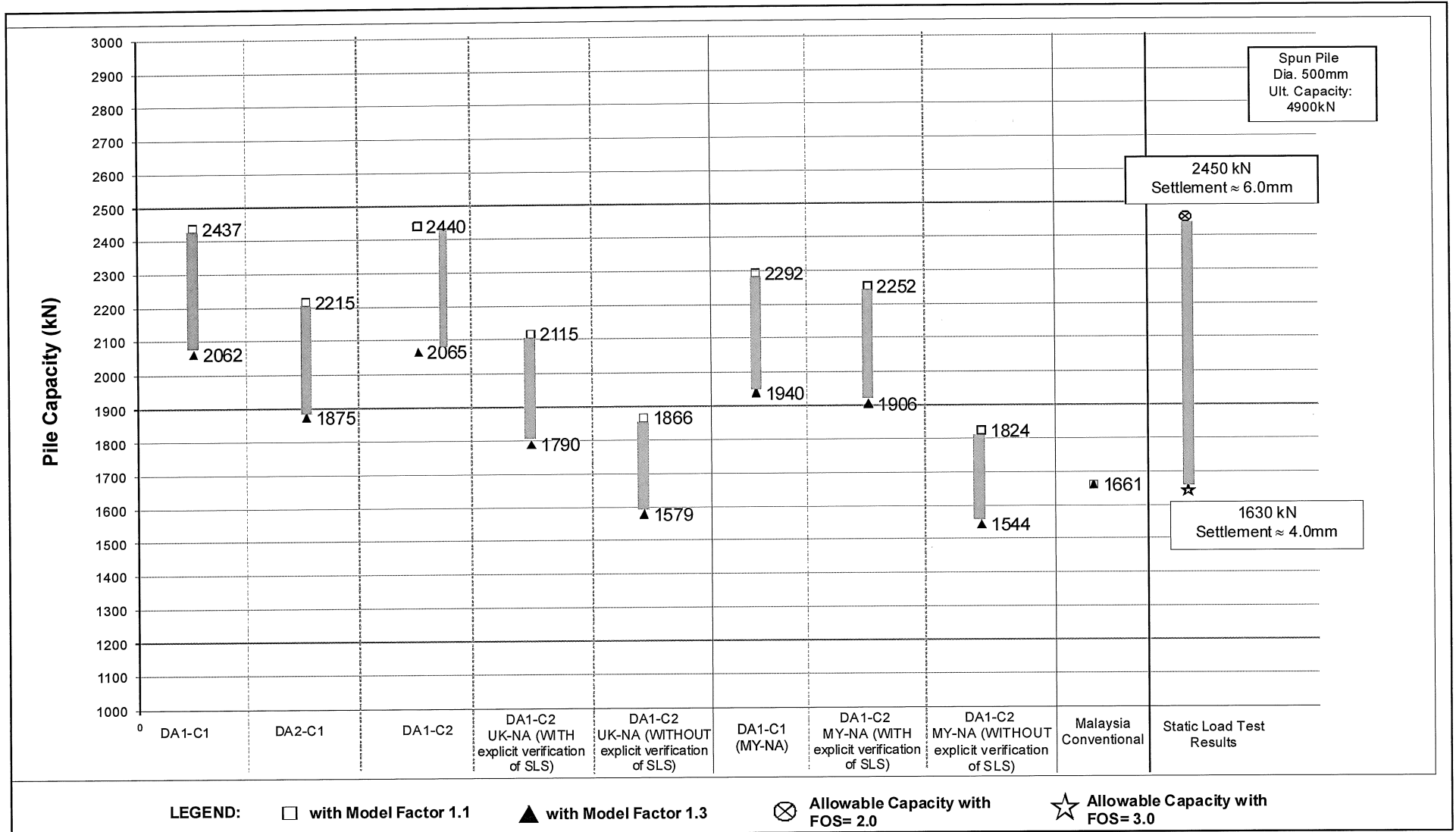

Figure 14. Allowable pile capacity of Jack-in Pile calculated using various methodologies compared with the Malaysian conventional design method and static pile load test results ($\phi 500\text{mm}$ Spun Pile – Site D).

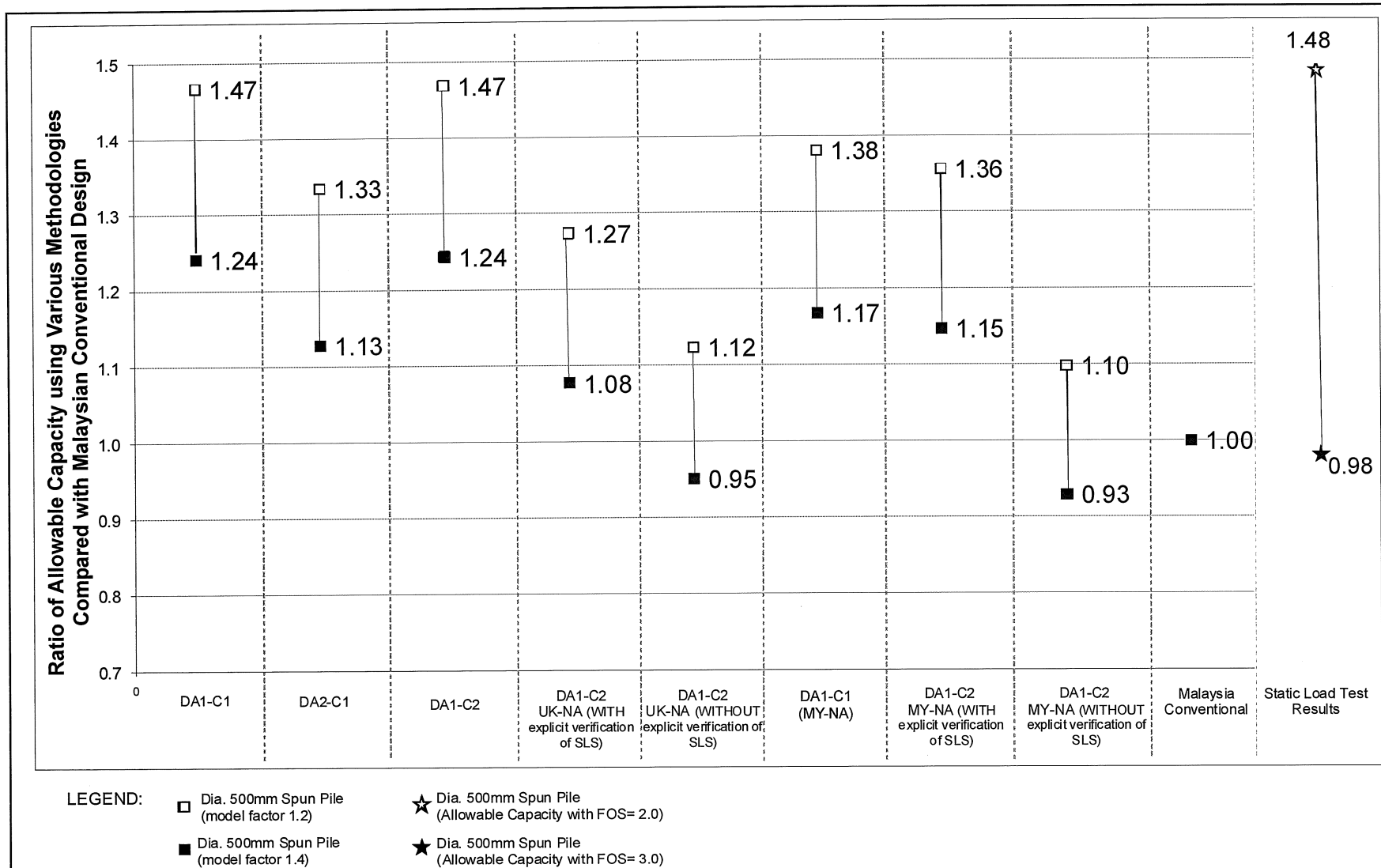

Figure 15. Ratio of Jack-in Pile allowable capacity calculated using various methodologies compared with the Malaysian conventional design method and static pile load test results.

REFERENCES

- Chin, F.K. (1970). Estimation of the ultimate load of piles not carried to failure. *Proc. 2nd SEA Conference on Soil Engineering*, Singapore, 81-90.
- Decourt, L. (1982). Prediction of the bearing capacity of piles based exclusively on N values of the SPT. *Proc. ESOPT2, Amsterdam 1*, 29-34.
- Deeks, A.D., White, D.J. & Bolton, M.D. (2005). A comparison of jacked, driven and bored piles in sand. *Proc. 16th ICSMGE*, Osaka, Japan, 2103-2106.
- European Committee for Standardization. (2004). Eurocode 7: Geotechnical design – Part 1: General rules.
- European Committee for Standardization. (2004). Eurocode 7: Geotechnical design – Part 2: Ground investigation and testing.
- Fellenius, B.H. (1990). Guidelines for the interpretation and analysis of the static loading test. *A continuing education sort course text by Deep Foundations Institute*, Sparta, N.J., USA.
- Fellenius, B.H. (2002). Determining the resistance distribution in piles. Part 1: Notes on shift of no-load reading and residual load. *Geotechnical News Magazine*, Vol. 20, No. 2.
- Krishnan, S. & Lee, S.K. (2006). A novel approach to the performance evaluation of driven prestressed concrete piles and bored cast-in-place piles. *Proc. 10th Int. Conf. on Piling and Deep Foundations*, Amsterdam.
- Meyerhof, G.G. (1956). Penetration tests and bearing capacity of cohesionless soils. *J. Soil Mechs. Fdn Engng, Am. Soc. Civ. Engrs*, 82, No. SM1, 1-19.
- Poulos, H.G. (1989). Pile behaviour-theory and application. *Geotechnique*, 39, No. 3, 365-415.
- Randolph, M.F. (2003). Science and empiricism in pile foundation design. *Geotechnique*, 53, No. 10, 847-875.
- Shioi, Y. & Fukui, J. (1982). Application of N -value to design of foundations in Japan. *Proc. ESOPT2, Amsterdam 1*, 159-164.
- Tan, Y.C., Wong, S.Y., Lee, C.B. & Gue, S.S. (2009). Comparison of Malaysian practice with EC7 on the design of driven pile and bored pile foundation under axial compression load. *IEM Course on Eurocode 7 – Geotechnical Design*, Petaling Jaya, 16-17 July 2009.
- White, D.J. & Lehane, B.M. (2004). Friction fatigue on displacement piles in sand. *Geotechnique*, 54, No. 10, 645-658.