

# Interpretation of Subgrade Reaction from Lateral Load Tests on Spun Piles in Soft Ground

*Ir. Tan Yean Chin, Ir. Dr. Gue See Sew & Ir. Fong Chew Chung  
G&P Geotechnics Sdn Bhd, Kuala Lumpur, Malaysia*

## ABSTRACT:

This paper presents the results and interpretation of a lateral load test on a fully instrumented spun pile in soft ground for the land viaduct section of a high speed train project in Alor Pongsu area. The lateral load test of the spun piles was carried out on a pile with fixed pile penetration to measure the lateral response of single pile and was tested by jacking against a reaction pile in accordance to ASTM D3966 – 1995.

Palmer and Thompson's (1948) formula for subgrade reaction ( $k_h$ ) was used to interpret the instrumented results of the lateral load test. Comparison with Davisson's proposed  $k_h$  with undrained shear strength ( $s_u$ ) was also made. The results show a correlation with the coefficient of subgrade reaction ( $n_h$ ) which removes the effect of subsoil depth and pile diameter. At depths up to 4m, Davisson's prediction is conservative but actual  $n_h$  is much higher due to overconsolidation of subsoil at shallow depths. For deeper subsoil, it slightly overpredicts due to passive resistance of the subsoil not yet fully mobilised. The back analysed Davisson's constant, is found to be 50 and is proposed for local soft ground conditions.

## 1.0 INTRODUCTION

The site is part of a project for a high speed railway traversing the northern region of Malaysia. Figure 1 shows the location of the site. A portion of the railway of about 28km length is supported by land viaducts due to its cost effectiveness and shorter construction duration as compared to piled embankment. As part of the pile verification tests, a fully instrumented preliminary test pile was installed and tested to validate the lateral pile performance.

This paper presents the interpretation of the subgrade modulus from the results of the fully instrumented lateral pile test. Subgrade reaction approach was used as the design of the land viaduct is based on pile bent approach where the foundation design is based on integral bridge design concept without bearings and minimum joints. This is a variation on the column bent approach where the supporting columns and foundation are replaced with individual supporting piles (Tonias, 1991). Hence, the bridge superstructure designer uses the subgrade reaction values as design input to analyse and design the forces in the land viaduct superstructure.

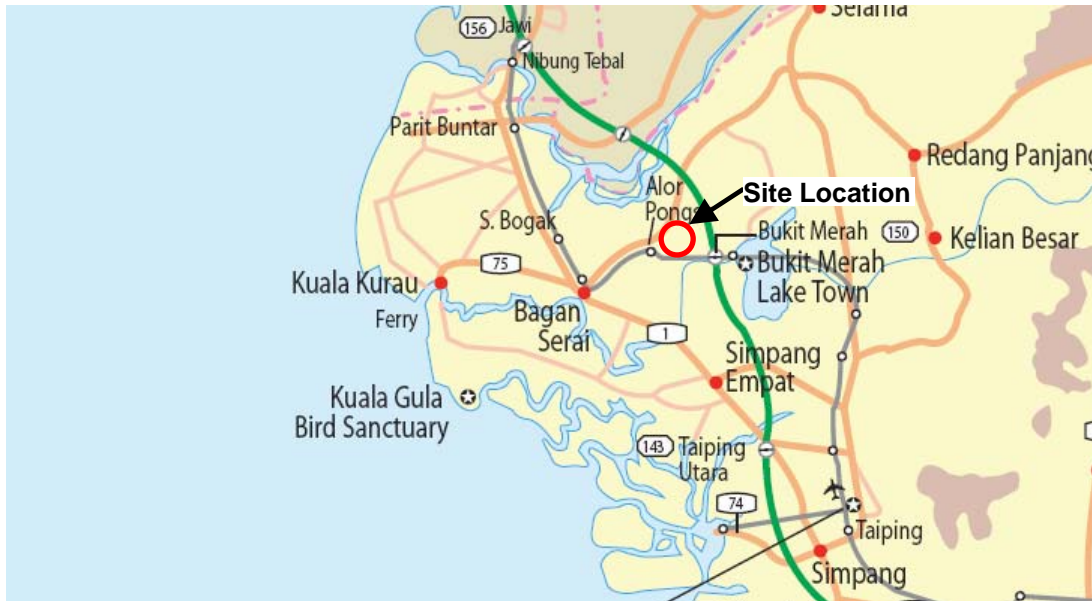

**Figure 1: Location of the Site**

## 2.0 LATERAL PILE RESPONSE MODELS

### 2.1 General

There are many methods of analysing the response of a laterally loaded pile. These methods can be categorised into subgrade reaction approach and elastic continuum approach. Subgrade reaction approach has been initially proposed by Palmer & Thompson (1948) and subsequently further developed by Reese and Matlock (1956). Further advancements lead to the development of  $p$ - $y$  curves and are commonly used to model the non-linear pile and soil behaviour. These have been described by McClelland and Focht (1958) and Davisson and Gill (1963). Further details and descriptions of  $p$ - $y$  curves are summarised by Reese & Van Impe (2001).

In this paper, the subgrade reaction approach is used to analyse the results of the instrumented test pile. This method is commonly used by bridge engineers to model and analyse pile bent structures. The historical development of subgrade reaction method begins with Winkler in 1867 modelling a beam on soil and subsequently adopting it to model embedded piles by others. It characterises the soil as a series of unconnected linearly-elastic springs in response to loading on the pile. In the model, the horizontal pressure ( $p$ ) and the corresponding deflection at a point ( $y$ ) is related by a horizontal modulus of subgrade reaction ( $k_h$ ):

$$p = k_h y$$

Where:

$p$  = soil reaction per unit length of pile

$y$  = pile deflection

$k_h$  = subgrade reaction in units of force/length<sup>2</sup>

Palmer & Thompson (1948) subsequently expressed the above equation in the form of:

$$k_h = k_L \left( \frac{z}{L} \right)^n$$

Where:

$k_L$  = value of  $k_h$  at pile toe ( $z = L$ )

$n$  = a coefficient greater than zero

For sands and normally consolidated clays under long term loading,  $n$  is taken as unity. For overconsolidated clays,  $n$  is commonly taken as zero. However, the commonly used form when  $n = 1$  and adopting a variation of  $k_h$  with depth:

$$k_h = n_h \left( \frac{z}{d} \right)$$

Where  $n_h$  is the coefficient of subgrade reaction and  $d$  is pile diameter.

This applies to cohesionless soils and normally consolidated clays where these soils indicate increasing strength with depth due to increase in overburden pressure.

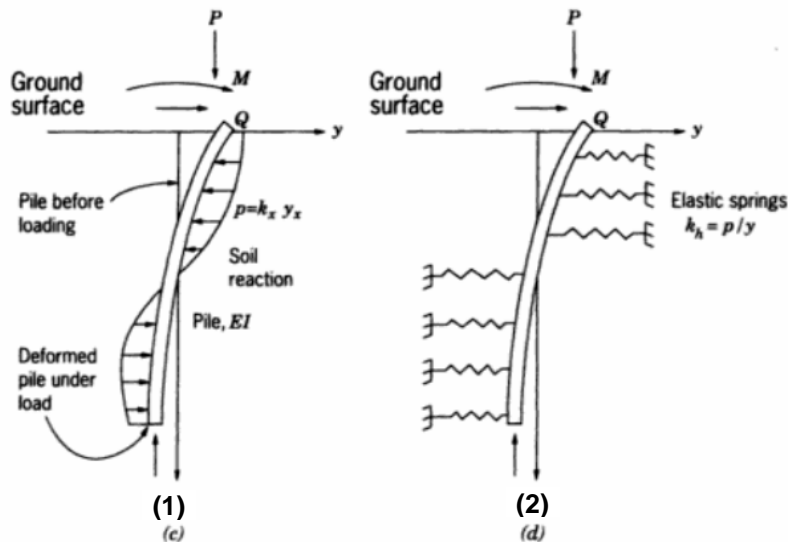

Figure 2 : Subgrade Reaction Model of (1) Actual Soil Reaction on Pile & (2) Elastic Spring Model of Soil Reaction - after Prakash & Sharma (1990)

## 2.2 Cohesive Soils

A number of empirical correlations for  $k_h$  in cohesive soils have been proposed by Broms (1946), Skempton (1951) and Baguelin et.al (1978).

Broms (1946):  $k_h = 1.67 * E_{50} / d$

Skempton (1951):  $k_h = (80 - 320) * C_u / d$

Where:

$E_{50}$  = secant modulus at half the ultimate stress in undrained test

$C_u$  = undrained shear strength

$d$  = pile diameter

However, for preliminary design before any verification test, a conservative approach suggested by Davisson's (1970) was used:

$$k_h = 67 \frac{C_u}{d}$$

For cohesive soils with  $k_h$  increasing linearly with depth,  $k_h$  is usually expressed in the form of  $k_h = n_h * z / d$ . Table 1 summarises the typical values of  $n_h$  for cohesive soils by various authors.

Soil Type	$n_h$ (kN/m <sup>3</sup> )	Reference
Soft NC Clay	163 – 3447 271 – 543	Reese & Matlock (1956) Davisson & Prakash (1963)
NC Organic Clay	179 - 271 179 – 814	Peck & Davisson (1962) Davisson (1970)
Peat	54 27 – 109	Davisson (1970) Wilson & Hiltz (1967)
Loess	7872 – 10858	Bowles (1968)

**Table 1: Typical Values of  $n_h$  for Cohesive Soils**

### 2.3 Cohesionless Soils

For piles in cohesionless soils, Terzaghi (1955) proposed :

$$n_h = A \frac{\gamma}{1.35} \quad (\text{tons/ft}^3)$$

Typical values of dimensionless factor A is shown in Table 2

Relative Density	Loose	Medium	Dense
Range of values of A	100 – 300	300 – 1000	1000 – 2000
$n_h$ , Dry moist sand (kN/m <sup>3</sup> ) [ton/ft <sup>3</sup> ]	2425 [7]	7275 [21]	19400 [56]
$n_h$ , Submerged sand (kN/m <sup>3</sup> ) [ton/ft <sup>3</sup> ]	1386 [4]	4850 [14]	11779 [34]

**Table 2: Typical Values of  $n_h$  for Cohesionless Soils - after Terzaghi (1955)**

### 3.0 LAND VIADUCT

The land viaduct consists of multiple spans, each span is typically 15m long between piers. Each 10.5m wide pier is supported by six 600mm diameter high strength

circular spun piles. The spacing between the piles is three times the pile diameter. In the pile bent design, the spun pile head is directly cast into the crosshead. Figure 3 shows a typical cross section of the land viaduct. This pile bent design is limited to 3m high between the ground level and the soffit of the crosshead. Figure 4 shows part of the completed land viaduct.

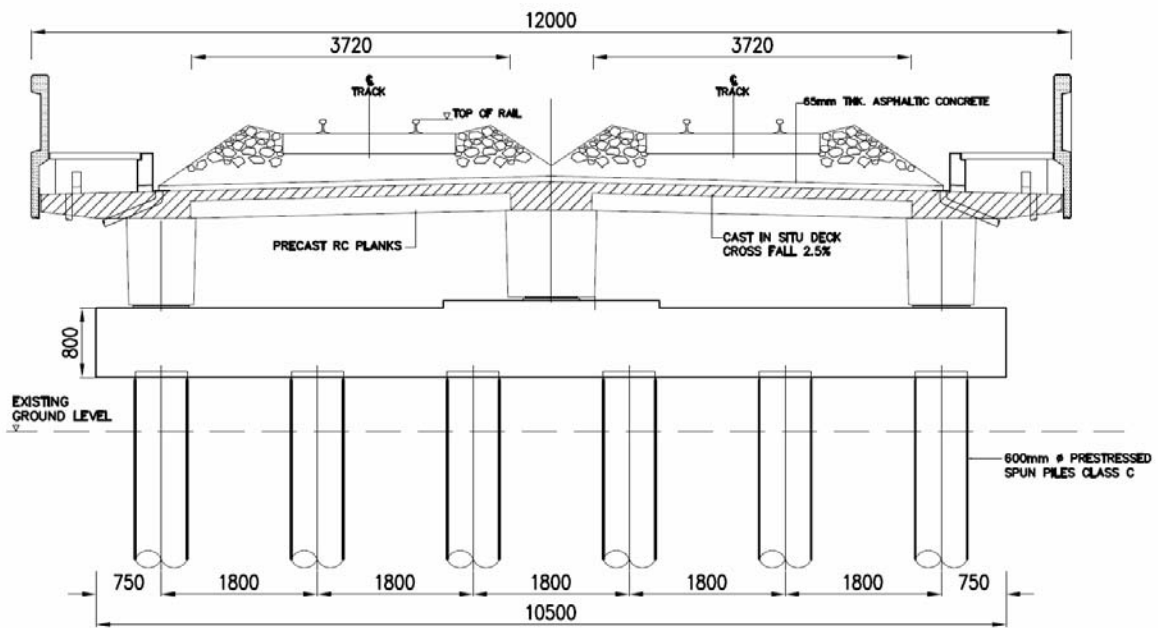

**Figure 3: Typical Cross Section**



**Figure 4: Completed Land Viaduct**

## 4.0 GEOLOGICAL AND GEOTECHNICAL CHARACTERISATION

### 4.1 General Geology

Most of the route of the project traverses near the coastal areas of western Peninsular Malaysia. These areas are often underlain by marine alluvium formation. Figure 5 shows the existing railway on the geological map.

The railway alignment traverses through different materials ranging from soft marine clay to dense residual soil. In the test pile area, the subsoil is generally of soft marine clay from Quaternary and Holocene periods. Table 3 describes the geology of these two sections. The test pile is located in Alor Pongsu, near Kamunting, Perak and is also indicated in Figure 5.

Section & Location	Formation	Age	Lithology
Taiping to Parit Buntar	Superficial Deposit	Quaternary	Gravel, Sand, Clay (Alluvium)

Table 3 : General Geology of the Site

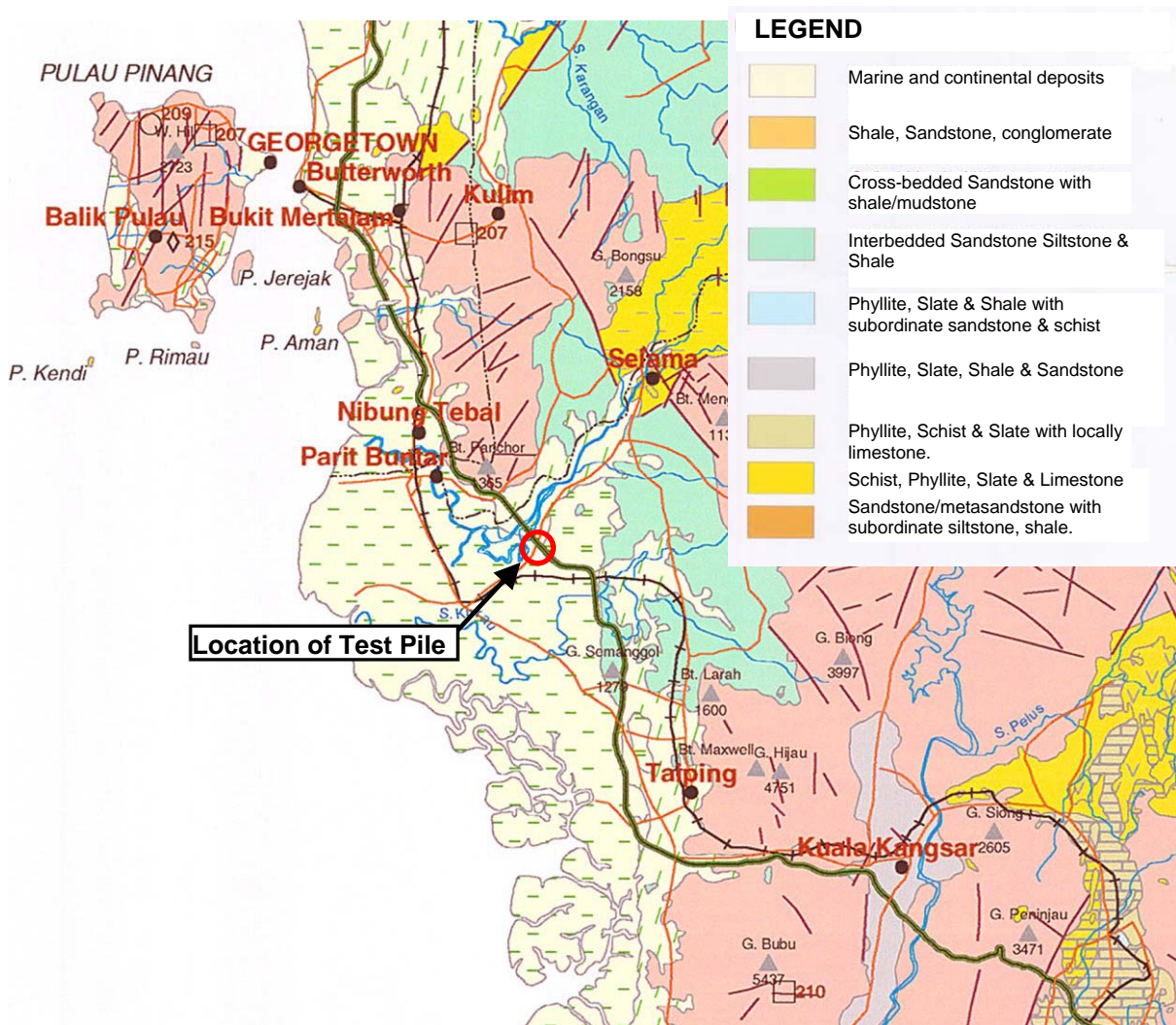
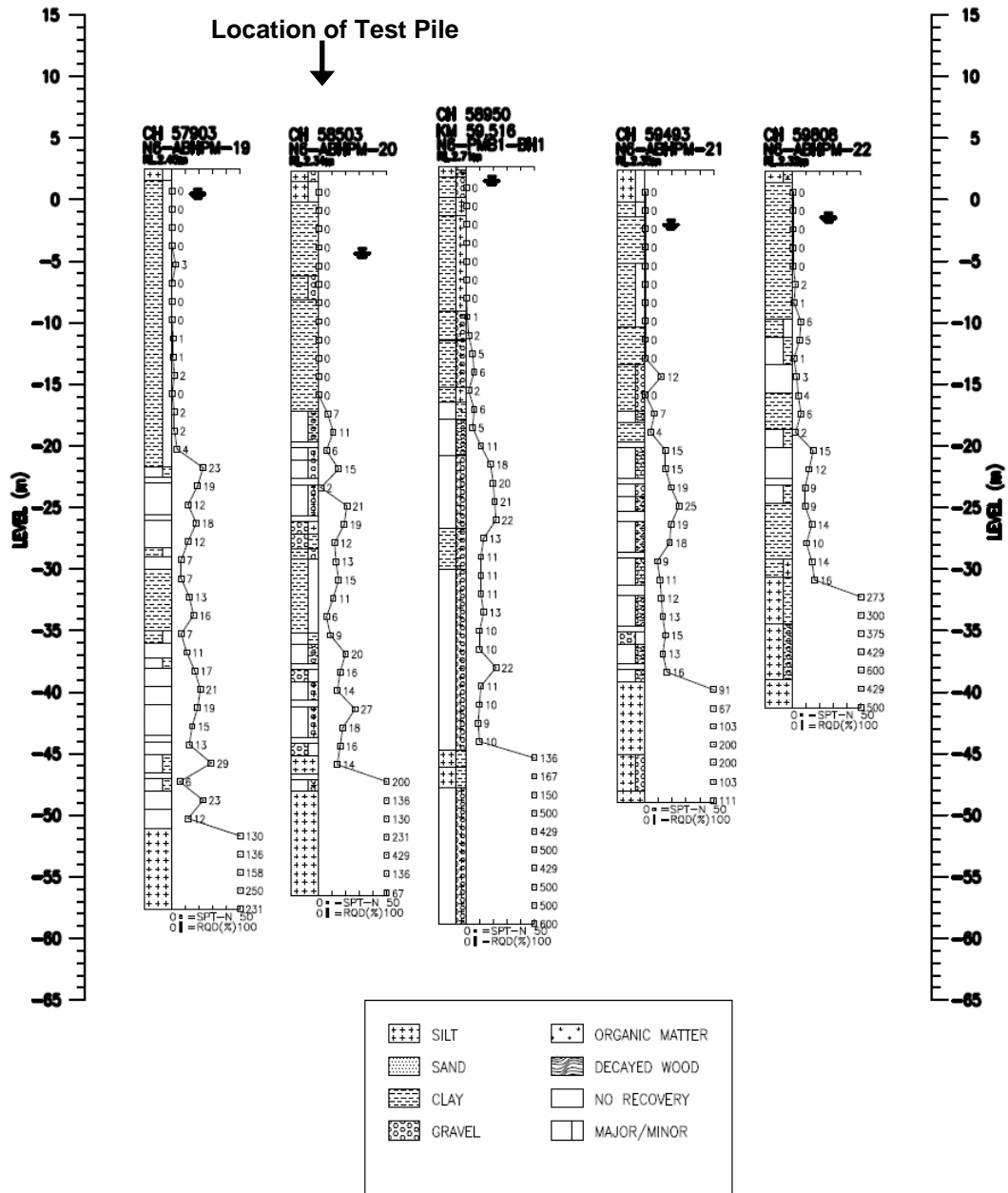

Figure 5: General Geology of the Site

## 4.2 Geotechnical Characterisation

Several series of subsurface investigation were carried out around Site A. These include boreholes, piezocones, field vane shear, mackintosh probes and associated laboratory tests. Figure 6 shows a few of the boreholes near the preliminary test pile while Figure 7 shows the laboratory test results on the soil samples collected.



**Figure 6: Borehole Logs**

From the borelogs, the test pile site is characterised as highly compressible marine alluvium with soft clay thickness of 15m to 30m. Soil classification tests show that the subsoil is generally of high to extremely high plasticity clay. In addition, it has high compressibility as shown by the compression ratio of 0.20 to 0.35 and recompression ratio of 0.055 (Figure 8). Stress history of the subsoil show that the upper 3m is overconsolidated while the clay stratum is generally slightly overconsolidated (Figure 9) and very soft as shown by the undrained shear strength profile (Figure 10). In such difficult subsoil conditions and where high fills is needed if embankment is used, land viaduct was adopted as a more cost and time effective

method of construction as compared to general ground treatment methods such as piled embankment.

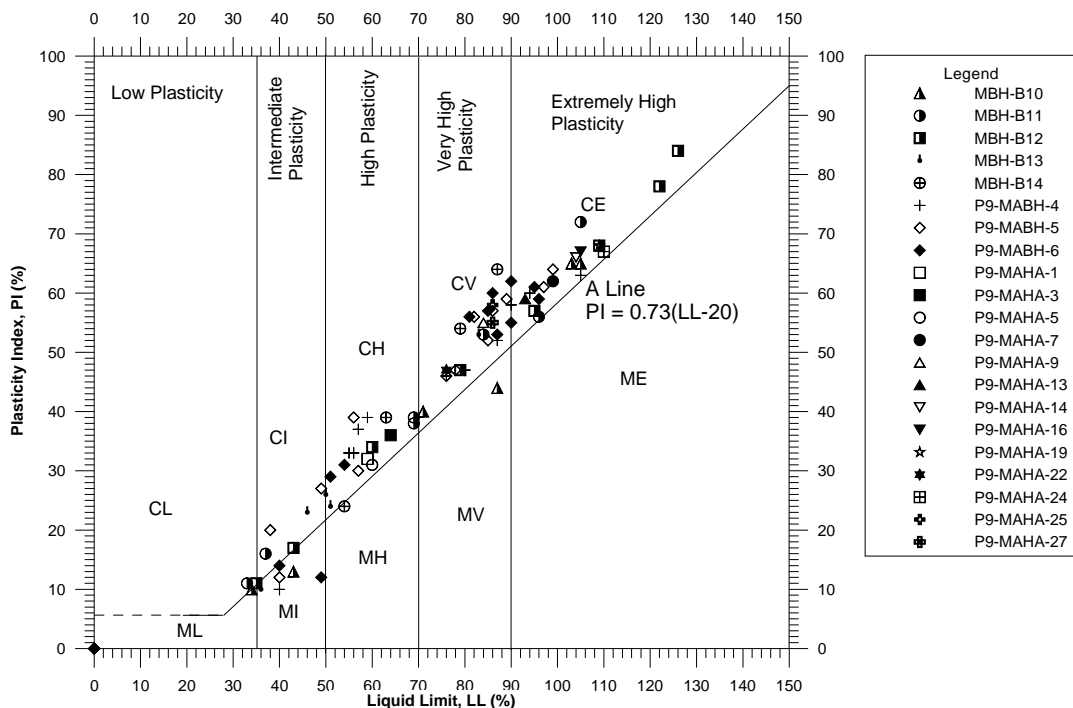

Figure 7: Soil Characterisation Test Results

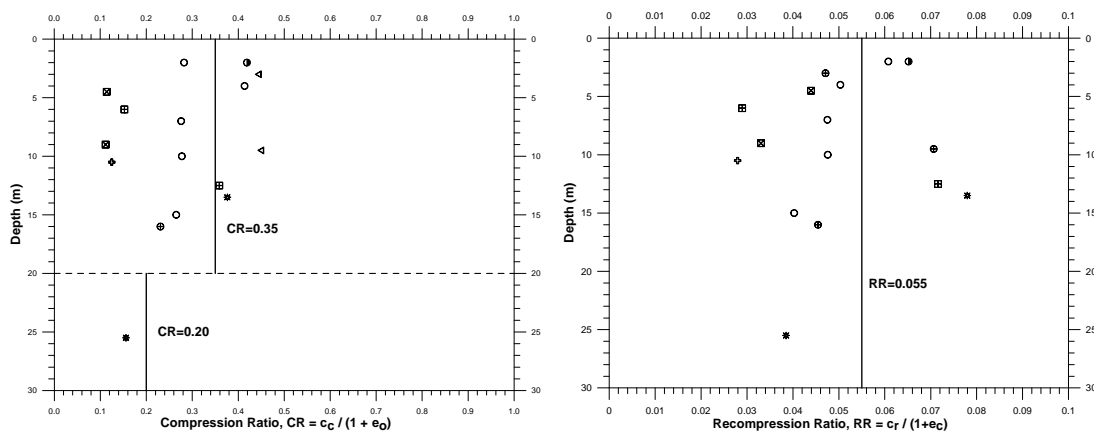

Figure 8: Compressibility of Subsoil

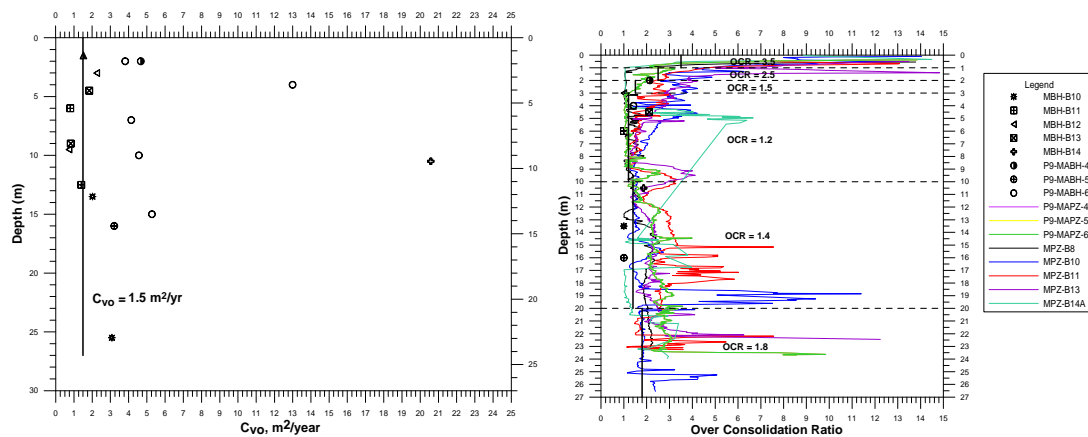

Figure 9: Soil Stress History and Consolidation Parameters

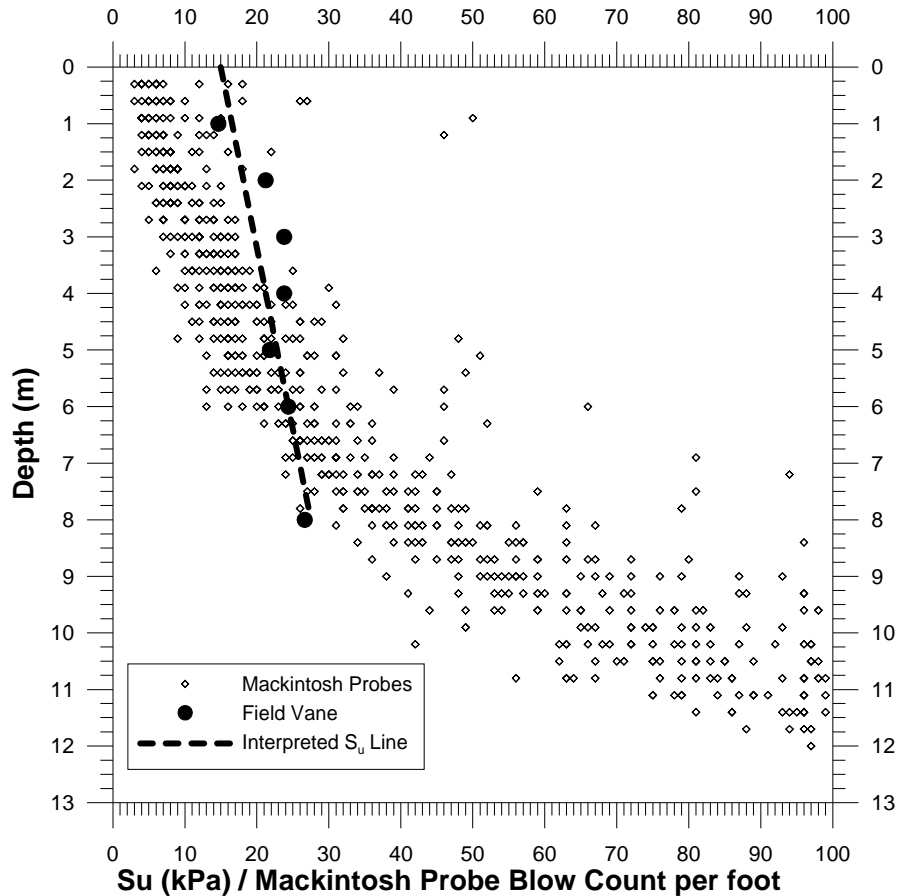

Figure 10: Undrained Shear Strength Profile

## 5.0 PILE PROPERTIES AND TEST SETUP

### 5.1 Test Setup

The lateral pile test was carried out according to ASTM D3966 – 1995 similar to the test setup for testing two piles simultaneously. The test pile is jacked against a similar or much stiffer reaction pile at some distance away. For this test setup, the distance between the two piles is 1.8m centre-to-centre (three pile diameters). Figure 11 shows the lateral pile test setup.

The preliminary test pile consists of a 600mm diameter grade 80 circular spun pile with wall thickness of 100mm. The pile is reinforced with 14 numbers of 10.7mm diameter PC strands with effective prestress of 7.0 MPa. Figure 12 shows the details of the test pile. The pile was driven to 36m depth and not to refusal as the aim of the test is to measure the lateral response of the pile which generally becomes insignificant after about 10 times the pile diameter.

The reaction pile is stiffer due to the thicker wall thickness of 120mm. The reaction pile was initially used for the preliminary axial compression test and the manufacturer had overcast the wall thickness to ensure the minimum 100mm thick sound concrete (excluding any laitance) was obtained after spinning. The stiffer spun pile was used as reaction pile as it would provide a better reaction mass due to it's higher stiffness.

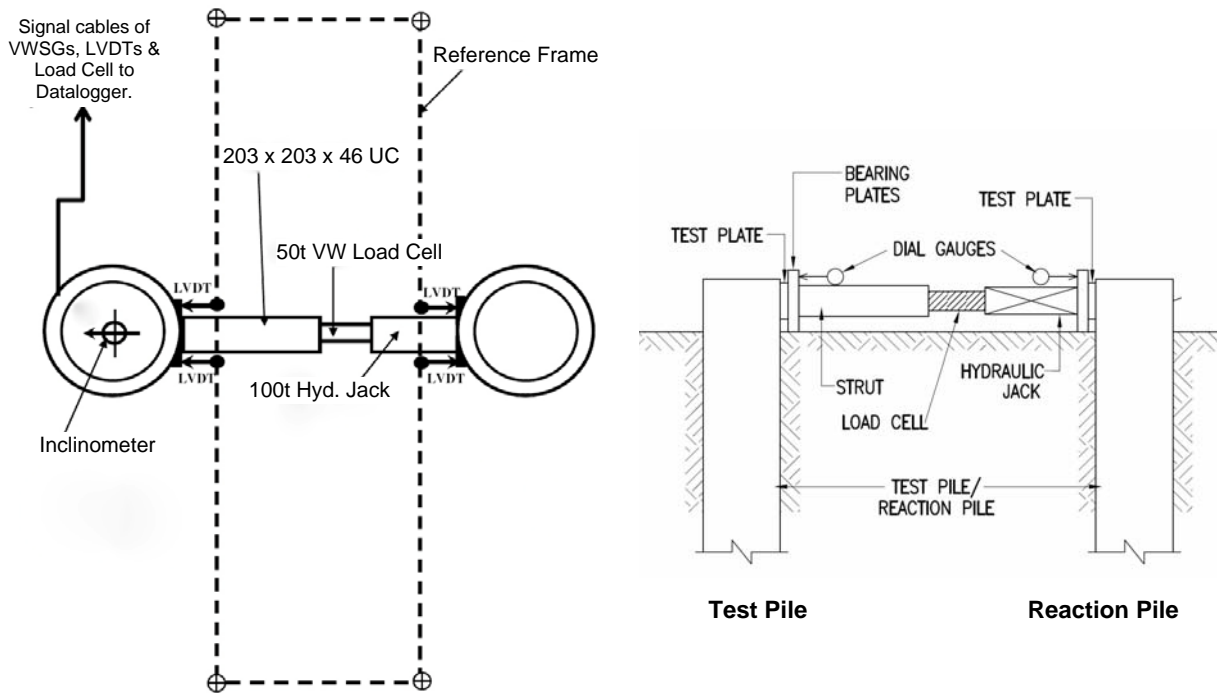

Figure 11: Lateral Pile Test Setup

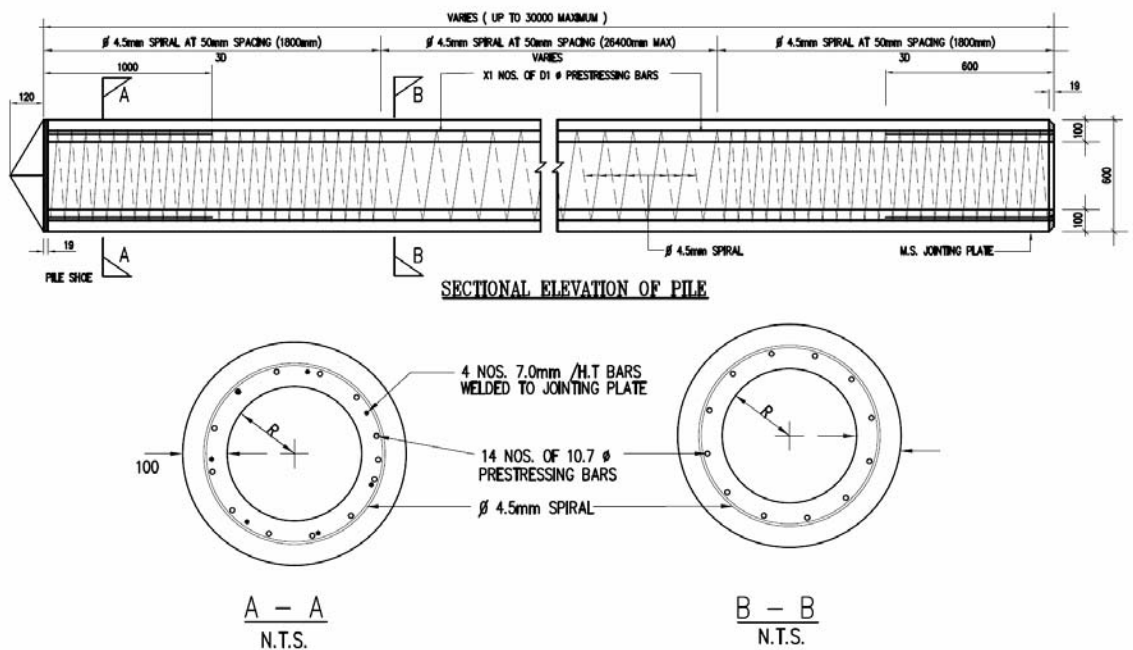

Figure 12: Details of Test Pile

## 5.2 Instrumentation Details

Instrumentation of the test pile consists of 12 levels of strain gauges at specified levels and inclinometer in the hollow middle of the spun pile as shown in Figure 13. The first six levels of strain gauges from ground surface have four strain gauges in a cross-axis layout in anticipation that some of the strain gauges may be damaged during pile installation. The remaining levels are instrumented with two strain gauges per level as the driving stresses at these levels are expected to be much less

compared to those near the impact point. All strain gauges were welded to the PC strands of the spun pile from the outer pile perimeter and housed in a protective 76x38x6.7kg/m C-Channel housing. Figure 14 shows the C-Channel housing on the test pile prior to pile installation.

The inclinometer is a 75mm diameter inclinometer tube installed centrally in the hollow centre of the spun pile with the aid of spacers. Subsequently, the void between the inclinometer tube and inner diameter of spun pile was grouted with bentonite –cement mix in the ratio of 1 : 7 to hold the inclinometer tube in place. Sample cylinders of the mix were cast during mixing to check the in-situ strength at 14 days when the pile test was carried out. The results on three cylinders showed an average unconfined compressive strength of about 633 kPa, which approximately corresponds to undrained shear strength of about 316 kPa and is sufficient for the purposes of the load test.

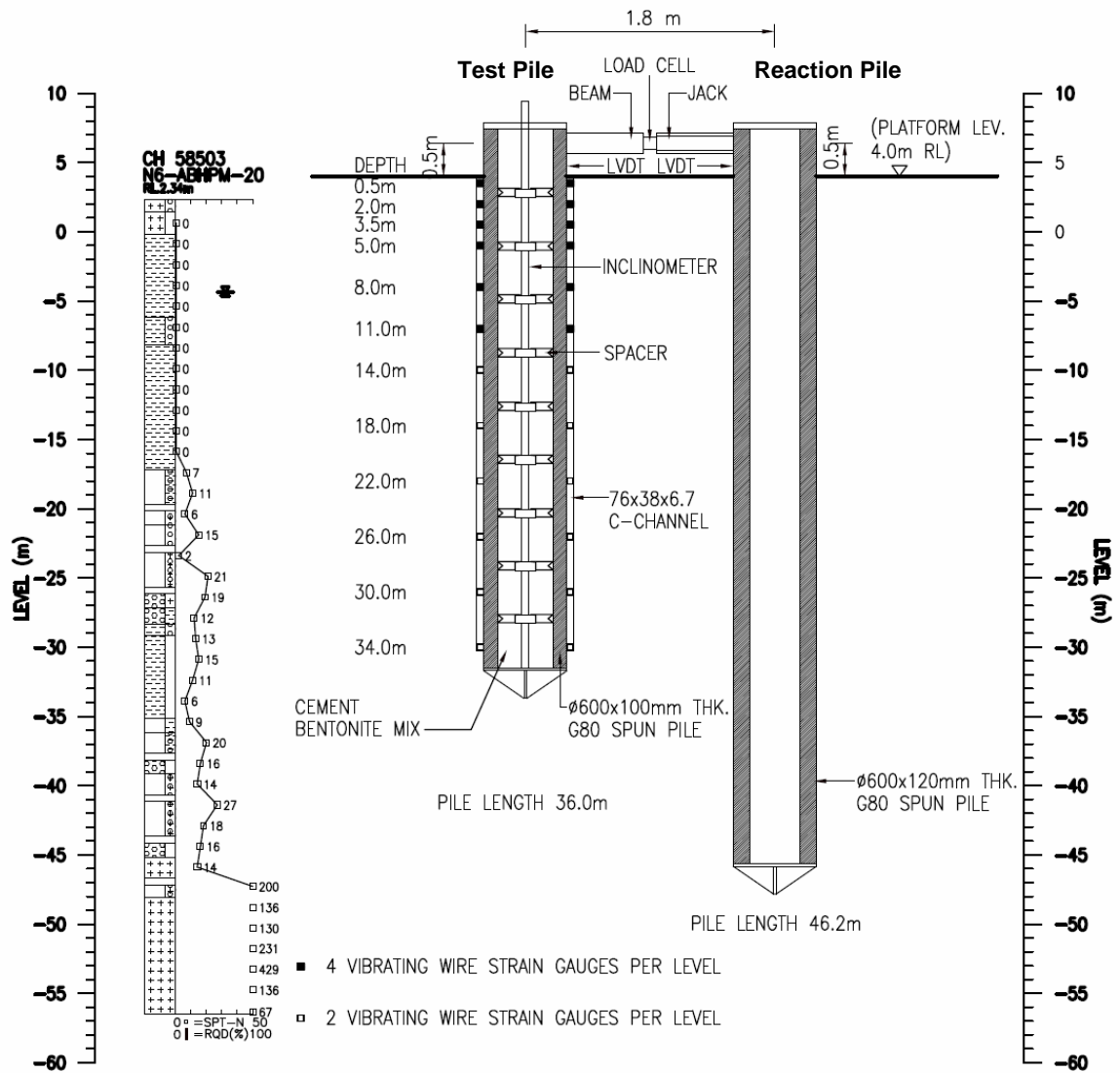

Figure 13: Elevation View of Testing Setup and Instrumentation Details



Figure 14: C-Channel Protection of Strain Gauges on Spun Piles (Lee, 2008)



Figure 15: View of Setup during Testing



**Figure 16: Top View of Test Pile with Inclinometer Tube**

## 6.0 LATERAL LOAD TEST

### 6.1 General

For this test, the pile was tested to a test load of 180 kN. Although the lateral pile working load is 50kN, the pile was tested beyond several times it's working load to observe the failure behaviour. The following are the pile design criteria from the bridge designer:

Lateral Pile Working Load (LPWL)	50 kN
Minimum Test Load (Lateral)	100 kN
Allowable Pile Head Deflection at 1 x LPWL	25 mm
Allowable Pile Head Deflection at 2 x LPWL	50 mm
Maximum Pile Service Moment	195.7 kNm

**Table 4: Pile Design Criteria**

The lateral load test was generally conducted in load increments of 10 kN to allow the inclinometer to register deflection along the pile length. Figure 17 shows the load schedule profile of the lateral pile test.

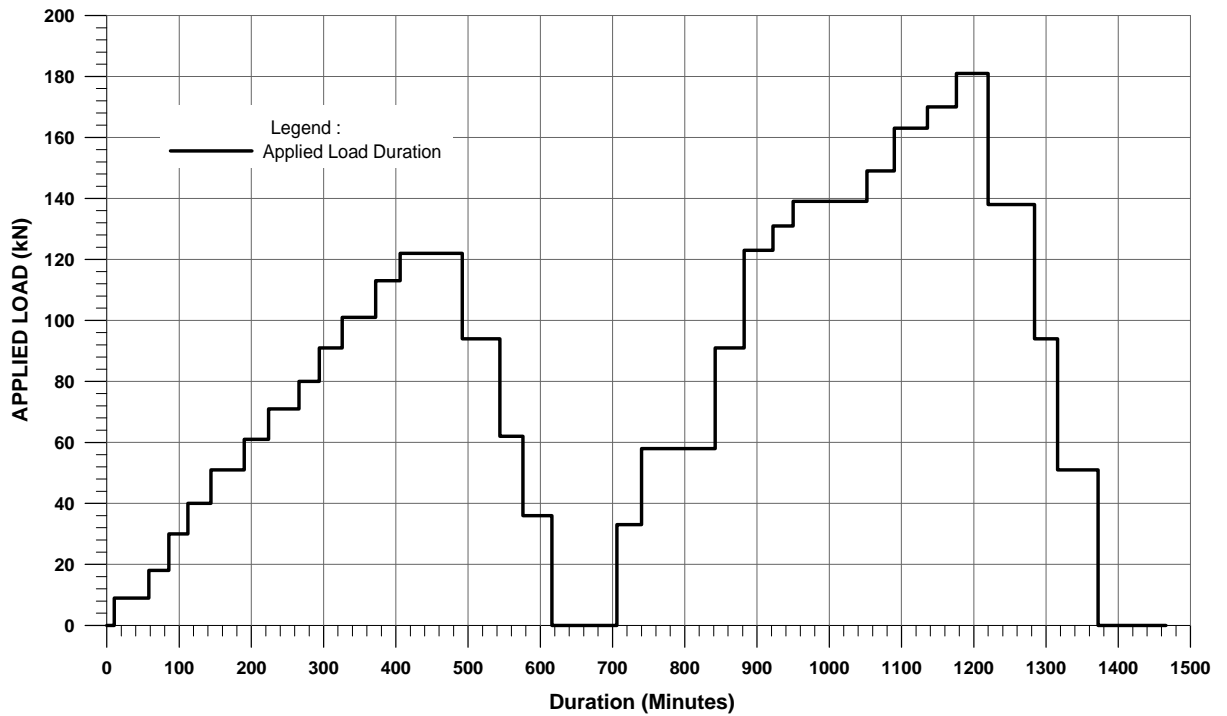

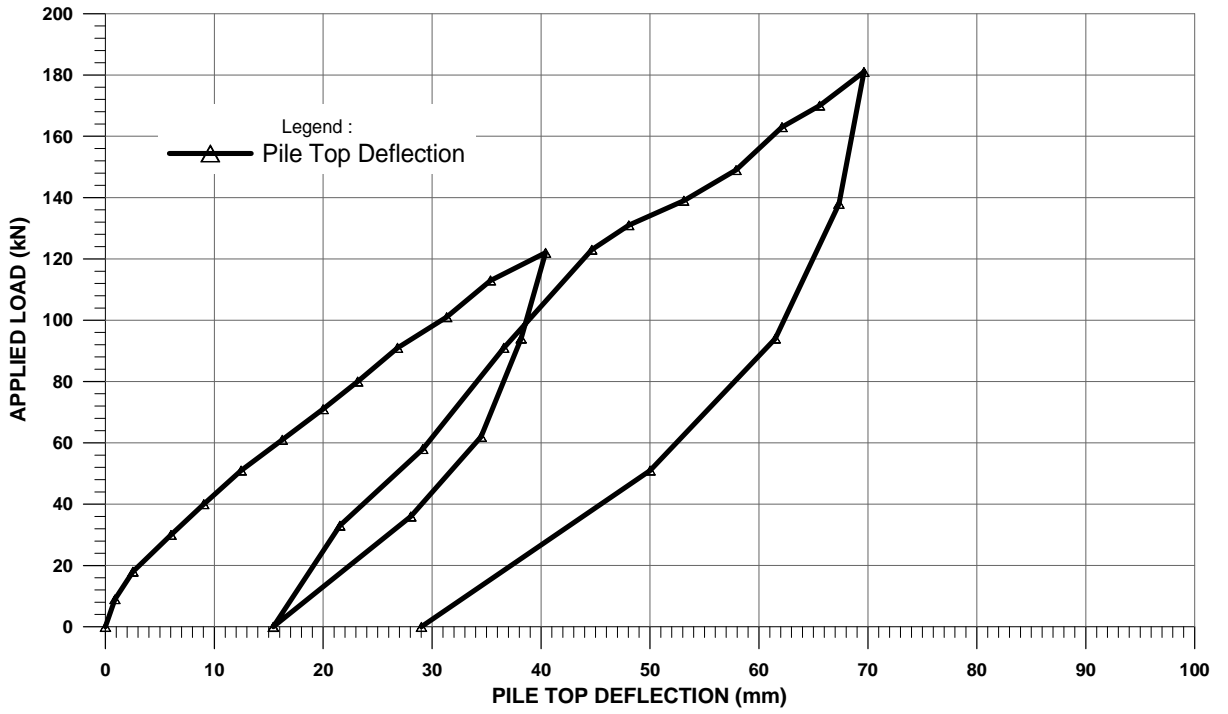

Figure 18: Pile Top Deflection vs Lateral Load

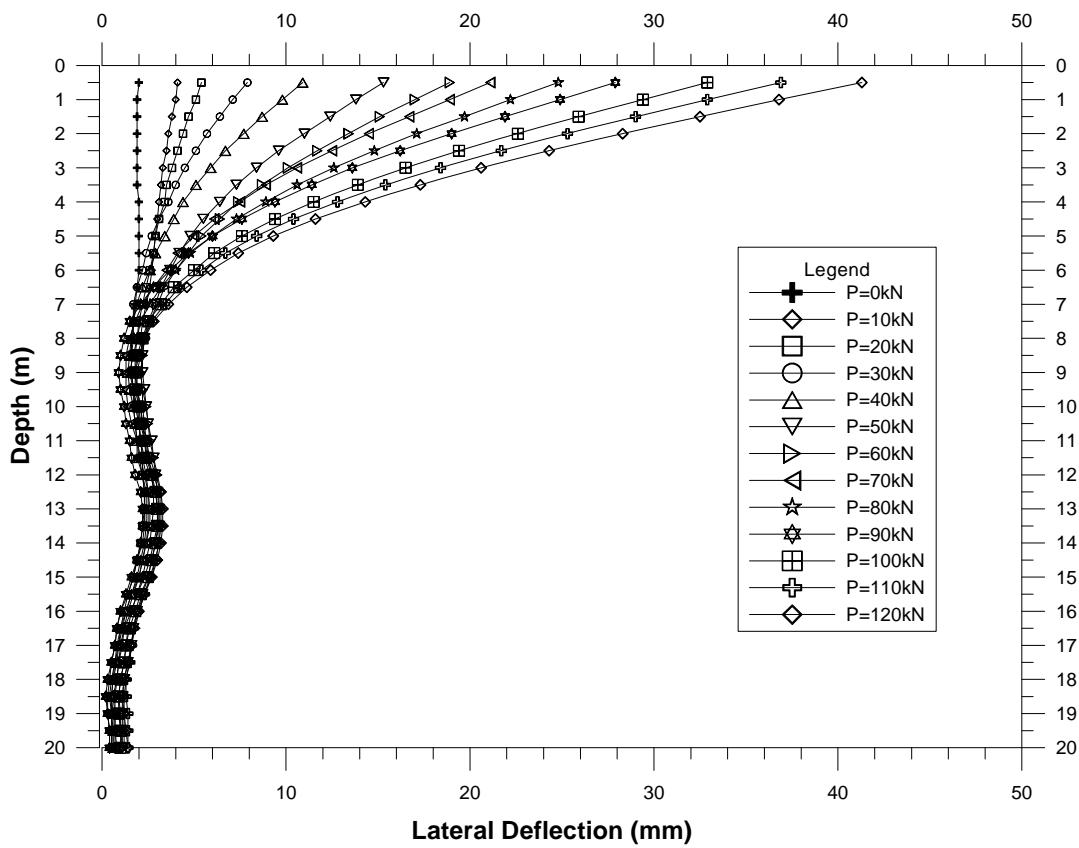

Figure 19: Deflection Results from Inclinator – 1st Load Cycle

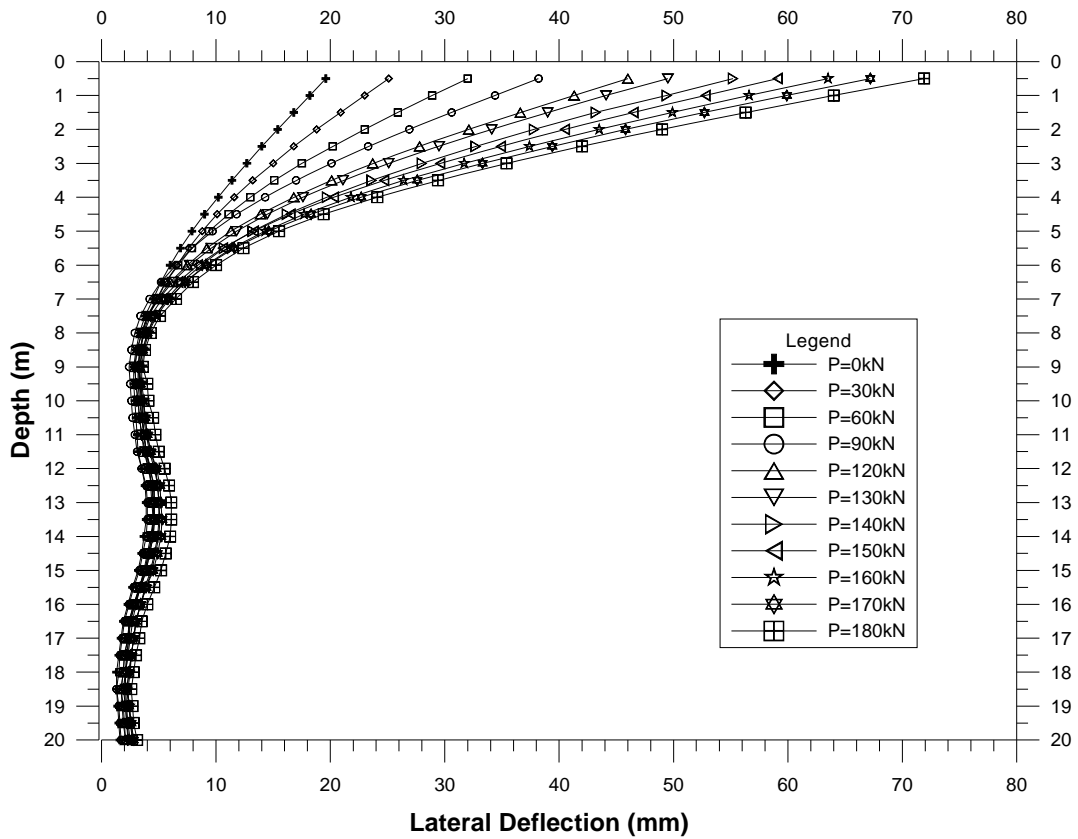

Figure 20: Deflection Results from Inclinometer – 2nd Load Cycle

## 7.0 INTERPRETED SUBGRADE REACTION

From the test results, the subgrade reaction was interpreted assuming a fixity point on the pile at 8m and a linearly varying soil pressure profile was determined for each applied load. At each depth, the soil pressure was interpolated from the linear soil pressure profile and the subgrade reaction ( $k_h$ ) was determined from the division of soil pressure by the horizontal deflection at each depth respectively.

The results were plotted in Figure 21 alongside the initial calculated subgrade reaction from Davisson's (1970). Generally, the subgrade reaction profiles show a peak at about five to six metres depth except for initial loading up to 20kN where the profile is dissimilar due to the horizontal soil pressures not fully mobilised.

Figure 22 shows the plot of interpreted subgrade reaction with applied load for several locations along the pile which indicates the subgrade reaction has mobilised to a peak at applied loads of about 100kN to 120kN before softening in response.

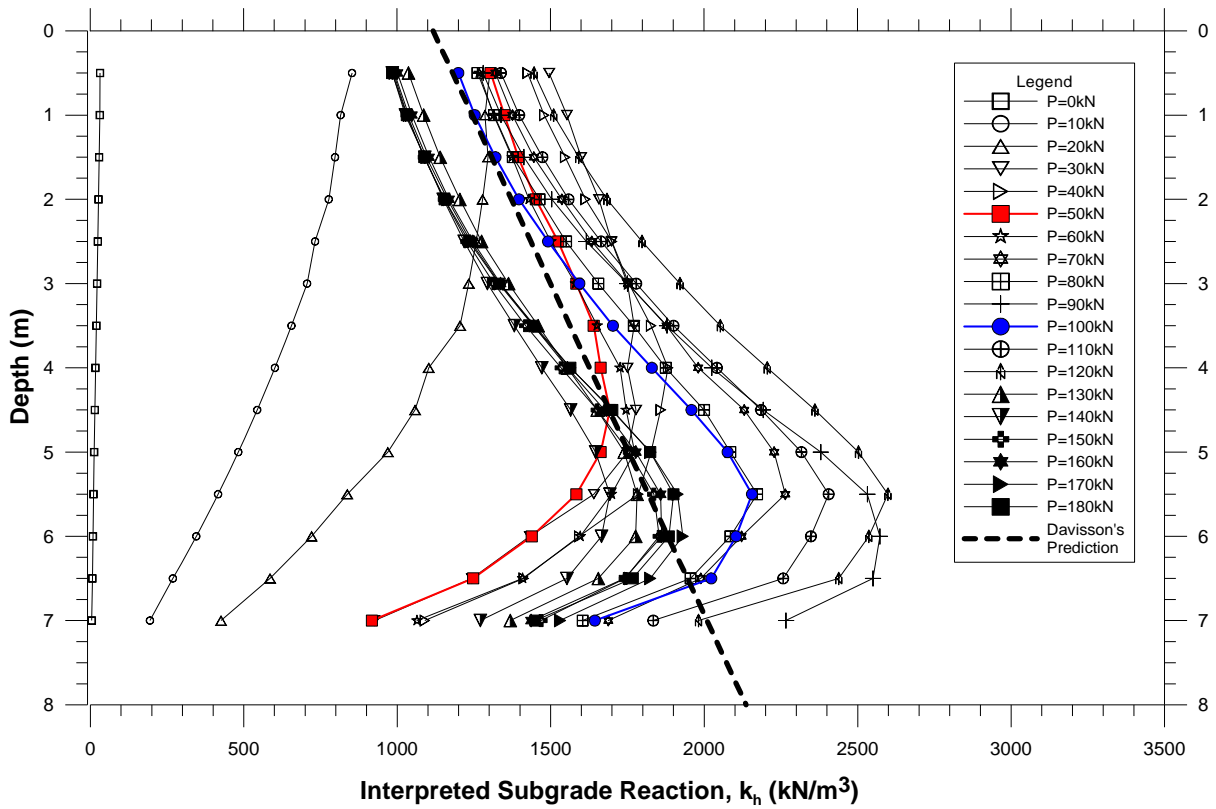

**Figure 21: Interpreted Subgrade Reaction**

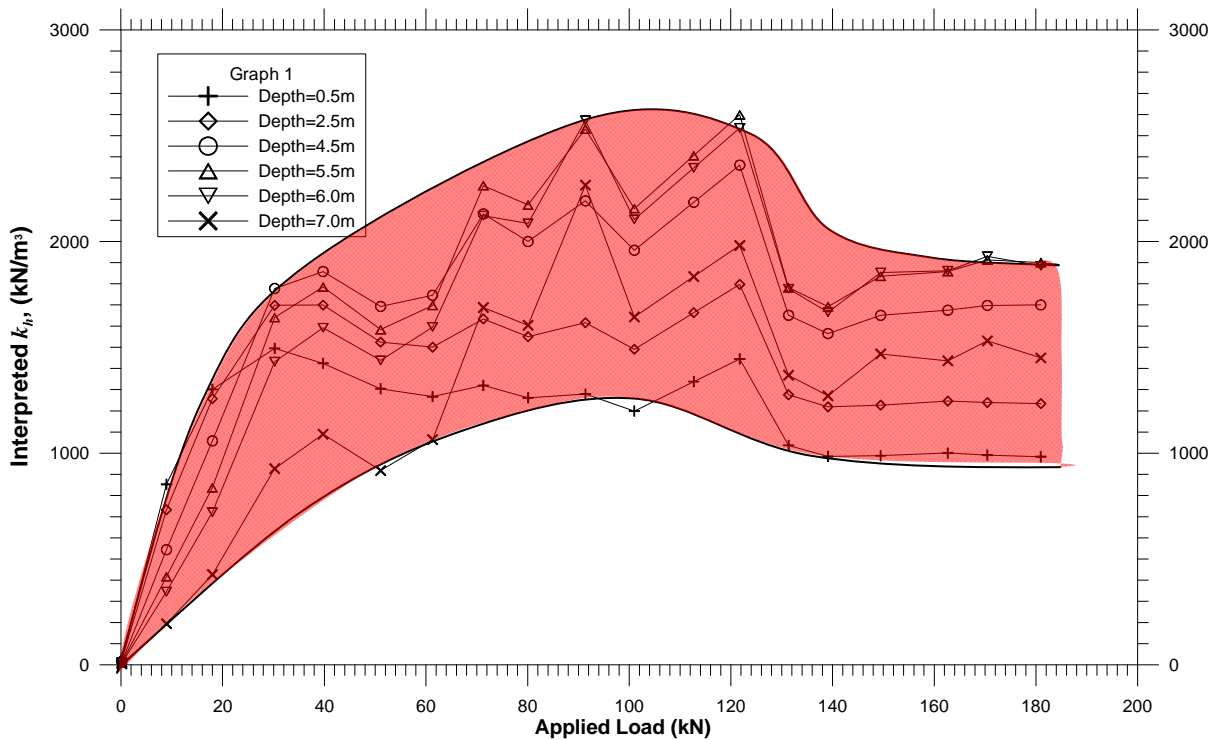

**Figure 22: Interpreted Subgrade Reaction vs Applied Load**

From the above plot, there is no visible trend of the subgrade reaction reaching peak then strain softening as the load increases. However, the results were plotted in the form of coefficient of subgrade reaction ( $n_h$ ) with depth for both load cycles and this removes the effect of pile diameter and subsoil depth. These were presented in Figure 23 with the initial predicted  $k_h$  converted from Davisson's (1970) plotted alongside.

In this plot, it can be seen that there is a general trend between the coefficient of subgrade reaction with subsoil depth. In addition, most of the plots are within a narrow range for most of the applied lateral load, suggesting the measured range of  $n_h$  values are closely within this range.

There is also a fair correlation between the predicted (Davisson's -1970) and the measured coefficient of subgrade reaction. At shallow depths,  $n_h$  tends to be underestimated significantly. However, this is probably due to overconsolidation of the subsoil stratum near the ground surface as the  $n_h$  profile is reminiscent of the OCR profile.

In the first load cycle, the subgrade reaction starts to be fully mobilised after applied lateral load of about 30kN. At 20kN, the profile indicates a partial mobilisation. At depths up to about 4m, Davisson's prediction is conservative but after 4m, it is slightly overpredicted. Overprediction at shallow depths is due to conservativeness in the selection of design line for the undrained shear strength. However, at deeper depths, the slight overprediction could be due to passive resistance not fully mobilised at that depth. The average  $n_h$  value for this site was found to be about 200 kN/m<sup>3</sup>.

In the second cycle, the general profile is similar to the first cycle but the  $n_h$  values have reduced indicating a softer response of the soil to loading and correspond with the expected behaviour in Figure 22. This could be due to the compressed soil after the first cycle and have not rebound back to it's original state after fully mobilising passive resistance and possible yielding.

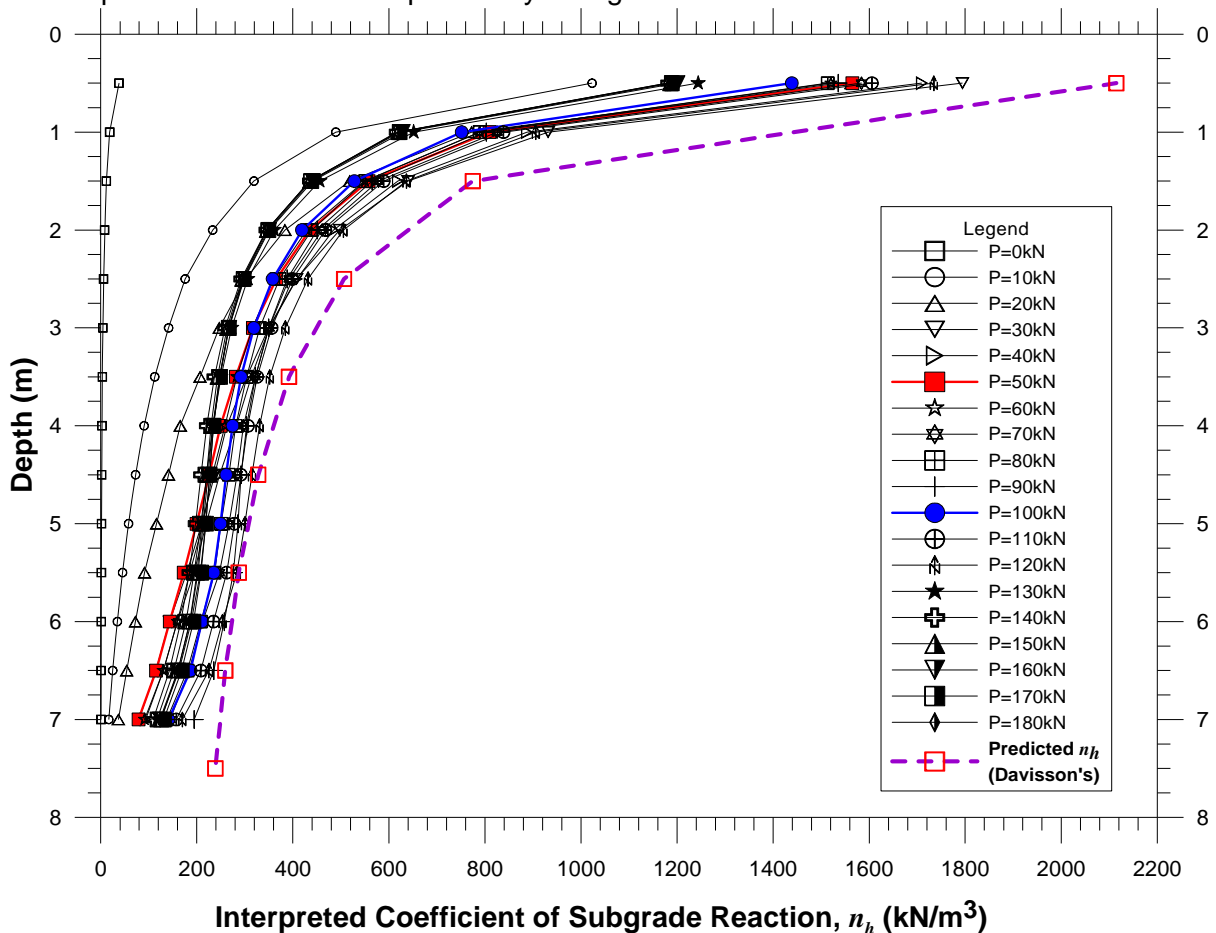

Figure 23: Interpreted Coefficient of Subgrade Reaction  $n_h$

Back analyses of the results were also carried out to determine Davisson's constant for the site. Figure 24 shows the results of the back analyses using the interpreted  $k_h$ . For this site, the proposed Davisson's constant is 50 as compared to 67 proposed by Davisson. This constant is more conservative and is proposed for soft ground in local ground conditions.

Overall, the initial prediction using Davisson's method shows fairly good estimate of the coefficient of subgrade reaction and subsequently the subgrade reaction values after taking into consideration the pile size and depth of subgrade.

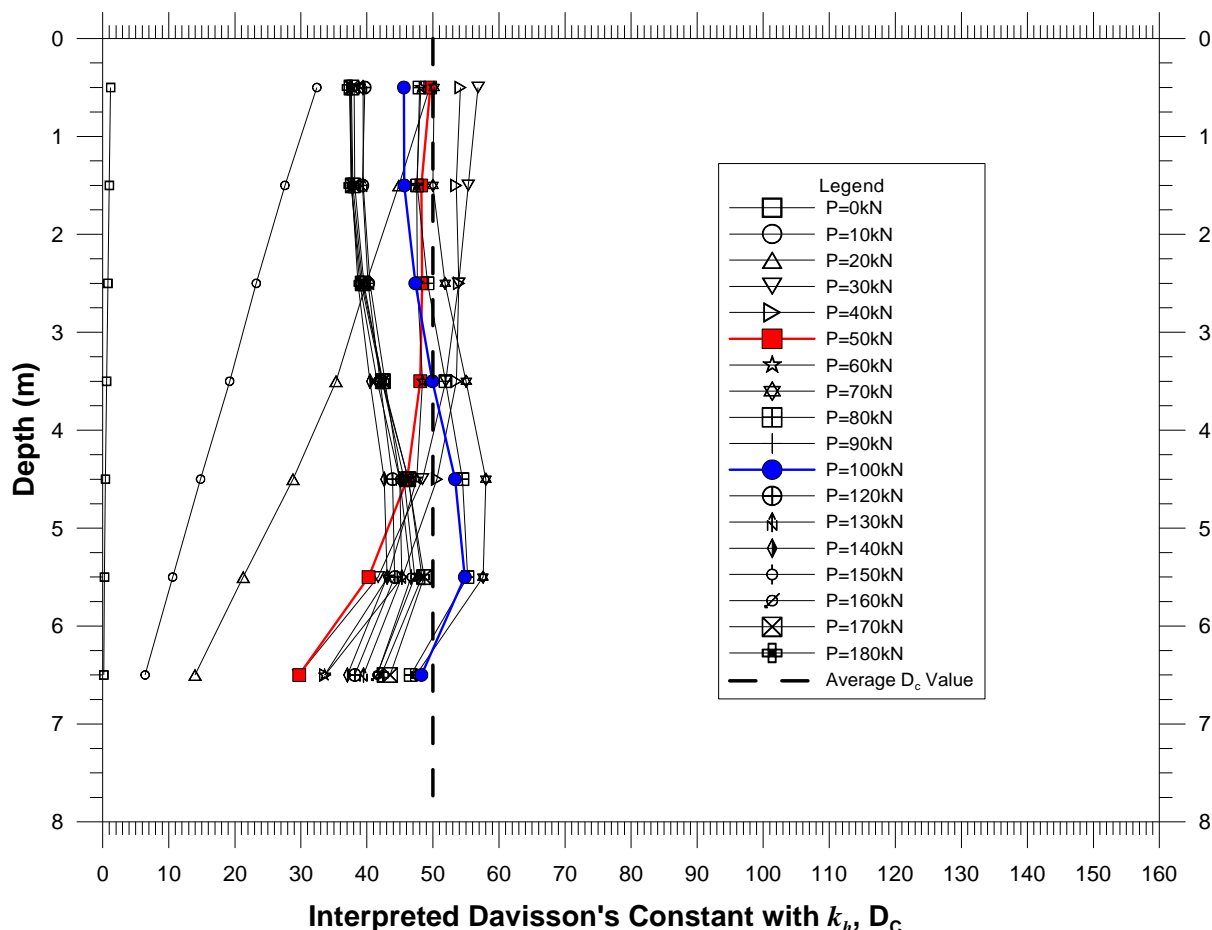

Figure 24: Back Analyses of Davisson's Constant ( $D_c$ ) with  $k_h$

## 8.0 CONCLUSIONS

A lateral load test was carried out on a fully instrumented preliminary (sacrificial) test pile to verify the lateral performance of 600mm diameter spun pile for the land viaduct section of a high speed train project. The land viaduct is built on soft marine clay which is highly compressible and with low undrained shear strength. Each of the pier in the land viaduct is supported by six numbers of 600mm diameter high strength circular spun piles spaced at three times the pile diameter. The instrumented lateral pile test was carried out according to ASTM D3966 – 1995 to verify the pile performance under lateral loading. The results of the test are further analysed to compare the initial prediction using subgrade reaction approach and recorded results.

The test pile was tested to maximum test load of 180kN in two cycles, well beyond the lateral pile working load (LPWL) of 50kN and proof load of twice the LPWL of 100kN. At LPWL, the maximum deflection was 12.5mm and at twice LPWL, the pile head deflection is about 31.3mm. The test results validate the design of the spun pile under lateral loading and deflection were within specified limits.

The test results were further analysed to interpret the subgrade reaction profile ( $k_h$ ) along the pile depth. Generally, interpreted subgrade reaction profile shows a peak at about five to six metres depth for all loading except for initial loading up to 20kN. This is due to the horizontal soil pressures not fully developed. In addition, the initial interpretation using subgrade reaction does not show any visible trend with applied lateral load.

However, when the results are plotted in the form of coefficient of subgrade reaction ( $n_h$ ) with depth, it show a fair correlation with predicted  $n_h$  using Davisson's method. At shallow depths,  $n_h$  tends to be underestimated significantly due to overconsolidation of subsoil stratum near the ground surface. At depths up to 4m, Davisson's prediction is conservative but slightly overpredicts after 4m depth due passive resistance not fully mobilised at those depths. The average  $n_h$  is 200 kN/m<sup>3</sup> for this site.

Back analyses of Davisson's constant for this project site show a proposed value of 50 compared to original value of 67 by Davisson. This is more conservative and is proposed for soft ground in local ground conditions. Overall, the initial prediction using Davisson's method shows fairly good agreement. However, for soft ground in Malaysia, the authors proposed a constant of 50 (ie.  $k_h = 67 \cdot S_u/d$ ).

## 9.0 REFERENCES

- Ahmadi, M.M. & Ahmari, S. (2007), "A Simple Approach to Investigate Laterally Loaded Pile-Soil Interaction," *Proceedings of 16<sup>th</sup> Southeast Asian Geotechnical Conference*, Subang Jaya, Malaysia.
- Baguelin, F., Jezequel, J.F. & Shields, D.H. (1978), *The Pressuremeter and Foundation Engineering*, Clausthal: *Trans Tech Publications*.
- Broms, B. B. (1964). "Lateral Resistance of Piles in Cohesive Soils." *Journal of Soil Mechanics and Foundations Div.*, Vol.90(2), 27–64.
- Chen, L.T. & Poulos, H.G. (1996) "Pile Response due to Unsupported Excavation-Induced Lateral Soil Movement", *Canadian Geotechnical Journal*, Vol.33 No.4, p. 670-677.
- Chen, L.T. & Poulos, H.G. (1997) "Piles Subjected to Lateral Soil Movements", *Journal of Geotechnical and Geoenvironmental Engineering*, Vol.123 No.9, pp.802-811.
- Coutinho, R.Q., Horowitz, B., Soares, F.L. & Braga J.M. (2005), "Steel Pile under Lateral Loading in a Very Soft Clay Deposit," *16<sup>th</sup> International Conference on Soil Mechanics and Geotechnical Engineering*, Vol. 4, Osaka.
- Davisson, M.T. (1970), "Lateral Load Capacity of Piles," *Highway Research Record, Transportation Research Board*, Washington, DC.
- Kucukarsalan, S., Banerjee, P.K. & Bildik, N. (2003), Inelastic Analysis of Pile Soil Structure Interaction, *Engineering Structure*: 1231-1239

- Lee, S.K. (2008), Photos of Instrumentation of Spun Pile, *Glostrext Technology Sdn Bhd*, [www.glostrext.com.my](http://www.glostrext.com.my).
- Mosher, R.L. & Dawkins, W.P. (2000), Theoretical Manual for Pile Foundations, *US Army Corps of Engineers*, Washington.
- Palmer, L.A. & Thompson, J.B. (1948). The Earth Pressure and Deflection Along the Embedded Lengths of Piles Subjected to Lateral Thrust. *Proceedings of the Second International Conference on Soil Mechanics and Foundation Engineering*, Rotterdam, vol. 5, pp 156-161.
- Poulos, H.G. & Davis, E.H. (1980), Pile Foundation Analysis and Design, *John Wiley & Sons*.
- Prakash, S. & Sharma, H.D. (1990), Pile Foundations in Engineering Practice, *Wiley-IEEE*.
- Reese, L.C. & Van Impe, W.F. (2001), Single Piles & Groups under Lateral Loading, *A.A. Balkema*, UK.
- Reese, L.C. & Welch, R.C. (1975a), Lateral Loading of Deep Foundation in Stiff Clay, *Journal of Geotechnical Engineering Division, ASCE*, Vol. 101 (GT7): 633-649.
- Reese, L.C., Cox W.P. & Koop, F.D. (1975b), Field Testing and Analysis of Laterally Loaded Piles in Stiff Clay. *Offshore Technology Conference*, Houston, Texas
- Rollins, K.M., Snyder, J.L. & Broderick, R.D. (2005), "Static and Dynamic Lateral Response of a 15 Pile Group." *Proceedings of 16th International Conference on Soil Mechanics and Geotech. Engineering*, Balkema.
- Skempton, A.W. (1951), "The Bearing Capacity of Clays", Building Research Congress, *London Institution of Civil Engineers*, div.I:pp.180
- Smith, T.D. & Ray, Brian (1986), "Shear Mobilization on Laterally Loaded Shafts." *Geotechnical Aspects of Stiff and Hard Clay*, New York, p. 60-68.
- Smith, T.D. & Slyh, R. (1985), Lateral Friction Mobilization Rates for Laterally Loaded Piles. *38th Canadian Geotechnical Conference*, Edmonton: 393-398
- Tan, Y. K. and Ting, W. H. (2004). "Design of Piles Subjected to Large Lateral Soil Movement." Special Lecture, *Proceedings of Malaysian Geotechnical Conference 2004*, Kuala Lumpur, March 2004, p. 149-164.
- Tonias, D.E. (1991), Bridge Engineering: Design, Rehabilitation and Maintenance of Modern Highway Bridges, *McGraw-Hill Professional*.
- Welch, R. C. & Reese, L. C. (1972), Laterally Loaded Behavior of Drilled Shaft, Research Report 3-5-65-89. *Center for Highway Research*. University of Texas, Austin